

PURION[®]
THE BEST SOLUTION

SURFACES 
SOLUTIONS FOR TREATMENT OF SURFACES

CATALOG OF PRODUCTS



UV: DISINFECTION WITHOUT CHEMICALS

UVC based disinfection operating principle

3



configuration options for monitoring of the PURION UV plants

4 - 8



disinfection of surfaces

9 - 18



equipment spare parts

19 - 28



company with tradition and innovation

29 - 32



Disinfection with UVC

OPERATING PRINCIPLE

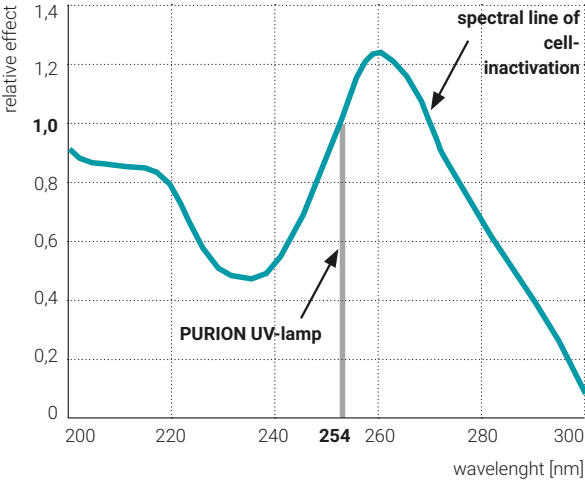
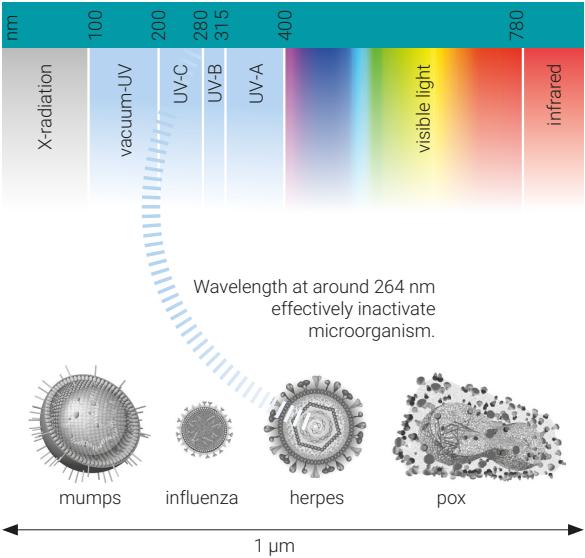

Microorganisms such as bacteria, moulds, yeasts and protozoa can be destroyed or removed by physical, biological and chemical methods.

UVC works using a photolytic effect whereby the radiation destroys or inactivates the microorganism so that it can no longer multiply. The phenomenon whereby microorganisms can be disfigured or destroyed is independent of host state (fluid or solid) and indeed pH or temperature.

Therefore disinfection of fluids, air and surfaces without using chemicals or high temperatures becomes possible in new applications.

Ultraviolet is that part of electro-magnetic radiation bounded by the lower wavelength extreme of the visible spectrum and the upper end of the X-ray radiation band. The spectral range of ultraviolet radiation is, by definition between 100 and 400 nm ($1\text{nm}=10^{-9}\text{m}$) and is invisible to human eyes.

A strong germicidal effect is provided by the radiation in the short wave UVC band. The UV radiation emitted by a source is expressed in watts (W) and the irradiation density is expressed in watts per square meter (W/m^2).

For germicidal action dose is important. The dose is the irradiation density multiplied by the time (t) in seconds and expressed in joules per square meter (J/m^2). 1 joule is 1 watt-second.

CONFIGURATION OPTIONS

FOR MONITORING OF THE PURION UV-PLANTS

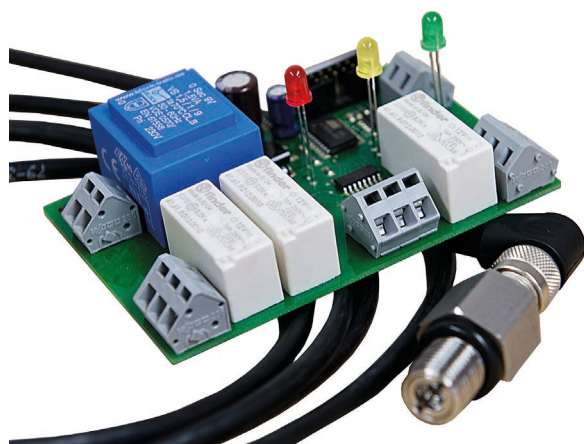

PURION guarantees disinfection for an operating time up to max. 10.000 h or max. 8.000 h for PURION UV-lamps with Amalgam technology for high ambient temperatures up to 90 C°.

After 10.000 h or 8.000 h of operation the UVC-intensity falls below 60% of the initial value. All technical performance data of the PURION UV plants have been derived from this "end of life" value.

Therefore the PURION UV-lamp has to be replaced after 10.000 h / 8.000 h.

The UVC-light that is decisive for disinfection has a wavelength of approx. 260 nm and cannot be detected by human eyes. In consequence it is not possible to determine the aging of the PURION UV-lamp without monitoring options.

Besides the basic monitoring of the operation status (control light) PURION provides several options for automatical detection and signaling of the lamps age and disinfection performance

With PURION configuration options for the monitoring of the UV plants it is guaranteed that the replacement of the UV-lamps is duly carried out.

PURION Monitoring of the UV-lamps operational time

Operating Time Counter – OTC



The Operating Time Counter (OTC) option monitors the life time of the UV lamp via summation of the operating time. The current status is displayed via LED's.

advantages	product line	Operating Time Counter – OTC
automatic recording of the exact operating time of the PURION UV lamps	voltage supply	230 V AC or 12 V DC or 24 V DC
automatic (pre-)alarm when lamp replacement is necessary	signal input	Operating Time Coter
optional configuration with potential free contacts for the LED signals	signal output	optional: potential free contact for any LED
safe reset procedure	load potential free contacts	up to 100 mA
maintenance free operation	special function	reset after replacement of the lamp
cost efficient monitoring option	steady light (green LED)	<95% of the warranted service life
	pre-alarm (yellow LED)	>95% <100% of the warranted service life
	main-alarm (red LED)	warranted service life has been exceeded

The OTC option works as a time counter and is integrated in the control box.

The monitoring system is designed as a traffic light. Two thresholds for the operating time have been saved:

- As long as the operating time is below 95% of the guaranteed life time the green LED is illuminated.
- If the operating time exceeds 95% of the guaranteed life time the yellow LED is illuminated (pre alert).
- If the operating time exceeds the guaranteed life time the red LED is illuminated (main alert). The UV lamp has to be replaced to ensure disinfection.

It is urgently recommended to clean the immersion tube system with the PURION Service KIT at latest during replacement of the UV lamps.

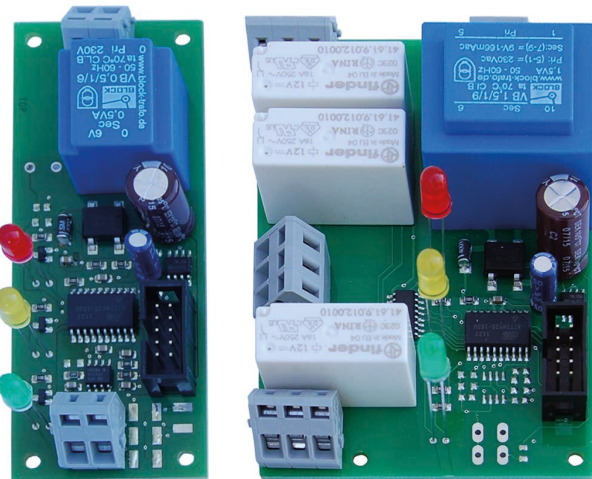

Additionally it is possible to configure the monitoring option OTC with potential free contacts for every LED. Therefore our clients are able to use information regarding the current status for additional switching operations (load potential free contact max. 100 mA).

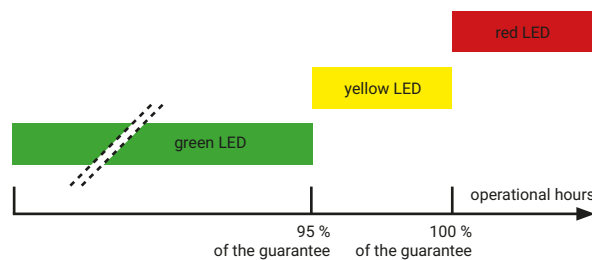

PURION Monitoring of the UVC-intensity

Operating Power Detection – OPD



The Operating Power Detection (OPD) option monitors the life time of the UV lamp via detecting the UV intensity. The current status is displayed via LED's.

advantages	product line	Operating Power Detection – OPD
automatic recording of the exact UVC intensity that is currently used for disinfection	voltage supply	230 V AC or 12 V DC or 24 V DC
automatic (pre-)alarm when lamp replacement is necessary	signal input	SiC-UV-Sensor
optional configuration with potential free contacts for the LED signals	signal output	optional: potential free contact for any LED
safe reset procedure	load potential free contacts	up to 100 mA
maintenance free operation	special function	calibration after replacement of the lamp
cost efficient monitoring option	steady light (green LED)	>70% of the initial intensity
	pre-alarm (yellow LED)	<70% and mind. 60% of the initial intensity
	main-alarm (red LED)	<60% of the initial intensity

The OPD configuration directly detects the UVC intensity via SiC-UV-Sensor.

The monitoring system is designed as a traffic light and integrated in the control box. Two thresholds for UV intensity have been saved:

- As long as the UV intensity is more than 70% of the initial value the green LED is illuminated.
- If the UV intensity goes below 70% of the initial value the yellow LED is illuminated.
- If the UV intensity goes below 60% of the initial value the red LED is illuminated. To ensure disinfection the UV lamp has to be replaced.

It is urgently recommended to clean the immersion tube system with the PURION Service KIT at latest during replacement of the UV lamps.

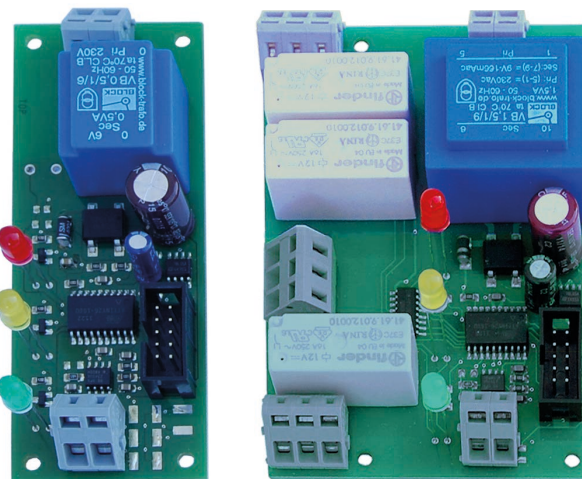

Additionally it is possible to configure the monitoring option OPD with potential free contacts for every LED. Therefore our clients are able to use information regarding the current status for additional switching operations (load potential free contact max. 100 mA).

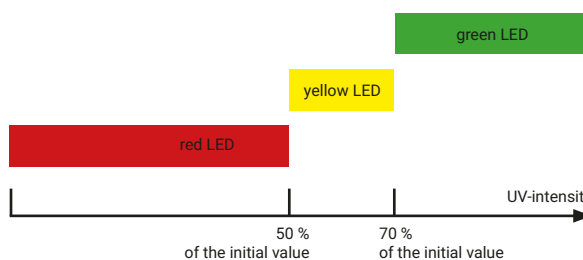

PURION UVC Sensor

in a stainless steel housing



This sensor is suitable for monitoring of the intensity of PURION UVC low-pressure lamps, PURION UVC high-output lamps and PURION UVC amalgam lamps.

properties of the SiC-sensor

wideband
UVA-UVB-UVC Photodiode

optimal ability for measuring powerful UVC radiation

silicon carbide chip warrants extreme radiation power

TO-18 metallic housing - 0.054 mm² active chip surface

product line PURION SiC Sensor

UV-intake 6 mm

angle spread approx. 30°

temperature 0°C up to 60°C

housing stainless steel 1.4571

connection flanges G ¼" SW 19

seal Viton

pressure-tight 10 bar

dimensions (L x Ø in mm) 45 x SW 19

signaling foto voltage

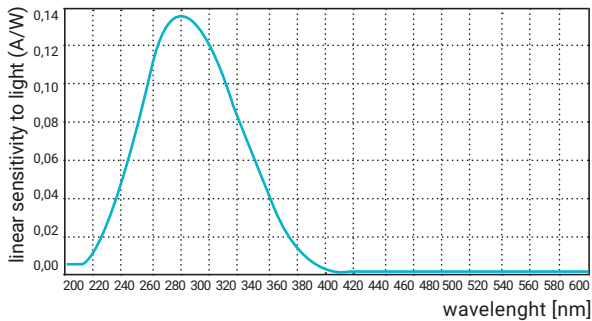

The sensor is equipped with a silicon carbide photodiode (SiC).

The photodiode has a very good sensitivity within the range of 250 and 260 nm. Therefore the diode is suitable to monitor UV light that is used for disinfection and with a peak emission rate at 254 nm.

This is in line with the DNS absorption curve.

The monitoring unit is designed as a traffic light. During monitoring the percentage of the UV intensity is evaluated.

PURION UVC Sensor

in a stainless steel housing
with integrated booster
and power output



This sensor is suitable for monitoring of the intensity of PURION UVC low-pressure lamps, PURION UVC high-output lamps and PURION UVC amalgam lamps.

properties of the SiC-sensor

wideband
UVA-UVB-UVC Photodiode

optimal ability for measuring powerful UVC radiation

silicon carbide chip warrants extreme radiation power

TO-18 metallic housing - 0.054 mm² active chip surface

product line PURION SiC Sensor 4-20 mA

UV-intake 6 mm

angle spread approx. 30°

temperature 0°C up to 60°C

housing stainless steel 1.4571

connection flanges G 1/4" SW 19

seal Viton

pressure-tight 10 bar

dimensions (L x Ø in mm) 67 x SW 19

power output 4-20 mA

supplied voltage 9-24 VDC

UVC-sensitivity approx. 30 - 300 W/m²

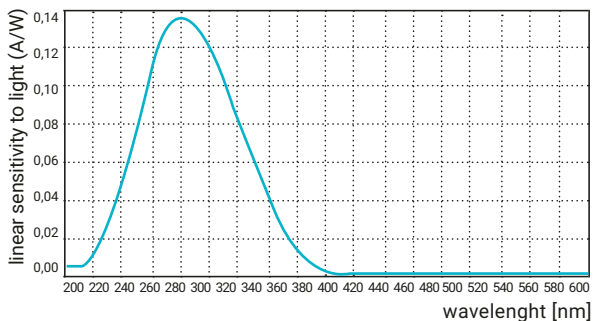

The sensor type is SiC-based and therefore only UV-sensitive (daylight blind).

High intrinsic insensibility against visible light through semiconducting material with high bandgap.

The snubber circuit of the sensor with 4...20mA enables the integration of the signal in Programmable Logic Controller (PLC) systems.

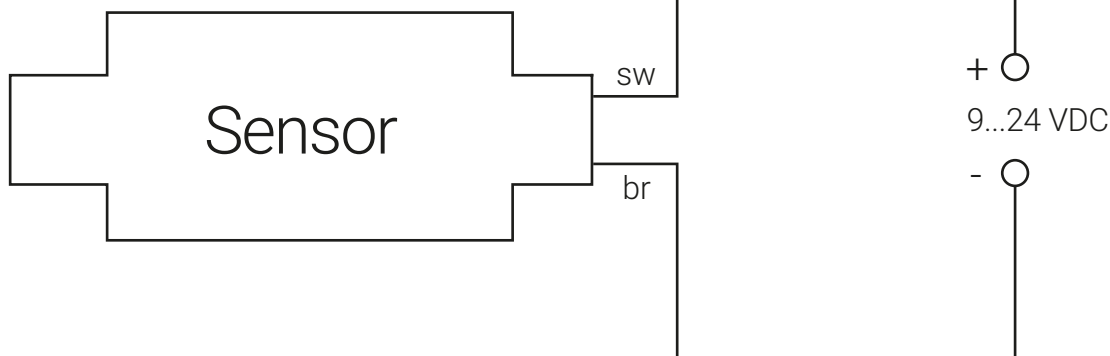

SURFACES

SOLUTIONS FOR TREATMENT OF SURFACES



PURION UV-modules

direct irradiation for disinfection of conveyor bands

10 - 13

AIRPURION-plants

Compact systems for direct irradiation

14 - 18

PURION UV-Module 300



The PURION UV MODULE 300 consists of an Aluminium housing that is unclosed in disinfection direction. It is possible to install the PURION UV MODULE 300 above or below the area to be disinfected. Therefore it is perfectly suitable for disinfection of conveyor bands etc. The UV-highly polished Aluminium surface (PVD coated) with increased reflection ensures an optimal usage of the UV radiation.

applications		product line	
disinfection of conveyor bands		PURION UV-Module 300	
disinfection of surfaces		disinfection performance:	
disinfection of packaging material		distance of 50 mm	200 J/m ²
		distance of 500 mm	60 J/m ²
		band width	≤ 300 mm
installation within air ducts		dimension (L x B x H in mm)	1000 x 600 x 100
dimensioning		configuration options	Operating Time Counter (OTC-main alarm), splinter protection
speed of the conveyor band	number PURION UV-Modules 300	number of lamps	8
0,0 - 0,5 m/s	1	number of electronic control cabinet Model 1	1
0,5 - 1,0 m/s	2	life time of lamps	10.000 h
1,0 - 1,5 m/s	3	electrical connection	3~/N/PE-50/60 Hz 230/400 V
1,5 - 2,0 m/s	4	total power	8x 48 W
		over current protection	3x 6 A

CONFIGURATION ELECTRIC CONTROL CABINET: Steel powder-coated

article number: 163 00100 0000
 article number: 163 00200 0000

• splinter protection
 • Operating Time Counter

article number: 163 00300 0000
 article number: 163 00400 0000

• splinter protection
 • Operating Time Counter

CONFIGURATION ELECTRIC CONTROL CABINET: stainless steel

article number: 163 00500 0000
 article number: 163 00600 0000

• splinter protection
 • Operating Time Counter

article number: 163 00700 0000
 article number: 163 00800 0000

• splinter protection
 • Operating Time Counter

equipment PURION UV-Module 300

PURION UV-lamp 48 W
 article number: 200 00500 0000



service-kit
 article number: 292 00900 0000



PURION UV-Module 700



The PURION UV MODULE 700 consists of an Aluminium housing that is unclosed in disinfection direction. It is possible to install the PURION UV MODULE 700 above or below the area to be disinfected. Therefore it is perfectly suitable for disinfection of conveyor bands etc. The UV-highly polished Aluminium surface (PVD coated) with increased reflection ensures an optimal usage of the UV radiation.

applications		product line	PURION UV-Module 700
disinfection of conveyor bands		disinfection performance:	
disinfection of surfaces		distance of 50 mm	200 J/m ²
disinfection of packaging material		distance of 500 mm	60 J/m ²
installation within air ducts		band width	300 - 700 mm
		dimension (L x B x H in mm)	1000 x 1000 x 100
		configuration options	Operating Time Counter (OTC-main alarm), splinter protection
		number of lamps	8
		number of electronic control cabinet Model 1	1
		life time of lamps	10.000 h
		electrical connection	3~/N/PE-50/60 Hz 230/400 V
		total power	8x 90 W
		over current protection	3x 6 A

dimensioning	
speed of the conveyor band	number PURION UV-Modules 700
0,0 - 0,5 m/s	1
0,5 - 1,0 m/s	2
1,0 - 1,5 m/s	3
1,5 - 2,0 m/s	4

CONFIGURATION ELECTRIC CONTROL CABINET: Steel powder-coated



article number: 163 00900 0000
article number: 163 01000 0000

splinter protection
Operating Time Counter

•



article number: 163 01100 0000
article number: 163 01200 0000

splinter protection
Operating Time Counter

•

•

CONFIGURATION ELECTRIC CONTROL CABINET: stainless steel



article number: 163 01300 0000
article number: 163 01400 0000

splinter protection
Operating Time Counter

•



article number: 163 01500 0000
article number: 163 01600 0000

splinter protection
Operating Time Counter

•

•

equipment PURION UV-Module 700

PURION UV-lamp 90 W
article number: 200 00600 0000



service-kit
article number: 292 00900 0000



PURION UV-Module 1000



The PURION UV MODULE 1000 consists of an Aluminium housing that is unclosed in disinfection direction. It is possible to install the PURION UV MODULE 1000 above or below the area to be disinfected. Therefore it is perfectly suitable for disinfection of conveyor bands etc. The UV-highly polished Aluminium surface (PVD coated) with increased reflection ensures an optimal usage of the UV radiation.

applications		product line	
disinfection of conveyor bands		PURION UV-Module 1000	
disinfection of surfaces		disinfection performance:	
disinfection of packaging material		distance of 50 mm	200 J/m ²
		distance of 500 mm	60 J/m ²
		band width	700 - 1000 mm
installation within air ducts		dimension (L x B x H in mm)	1000 x 1000 x 100
dimensioning		configuration options	Operating Time Counter (OTC-main alarm), splinter protection
speed of the conveyor band	number PURION UV-Modules 1000	number of lamps	16
0,0 - 0,5 m/s	1	number of electronic control cabinet Model 1	2
0,5 - 1,0 m/s	2	life time of lamps	10.000 h
1,0 - 1,5 m/s	3	electrical connection	3~/N/PE-50/60 Hz 230/400 V
1,5 - 2,0 m/s	4	total power	8x 48 W + 8x 90 W
		over current protection	3x 6 A

CONFIGURATION ELECTRIC CONTROL CABINET: Steel powder-coated



article number: 163 01700 0000
article number: 163 01800 0000

splinter protection
Operating Time Counter



article number: 163 01900 0000
article number: 163 02000 0000

splinter protection
Operating Time Counter



CONFIGURATION ELECTRIC CONTROL CABINET: stainless steel



article number: 163 02100 0000
article number: 163 02200 0000

splinter protection
Operating Time Counter



article number: 163 02300 0000
article number: 163 02400 0000

splinter protection
Operating Time Counter



equipment PURION UV-Module 1000

PURION UV-lamp 48 W
article number: 200 00500 0000



PURION UV-lamp 90 W
article number: 200 00600 0000



service-kit
article number: 292 00900 0000



PURION UV-Module 1400



The PURION UV MODULE 1400 consists of an Aluminium housing that is unclosed in disinfection direction. It is possible to install the PURION UV MODULE 1400 above or below the area to be disinfected. Therefore it is perfectly suitable for disinfection of conveyor bands etc. The UV-highly polished Aluminium surface (PVD coated) with increased reflection ensures an optimal usage of the UV radiation.

applications	
disinfection of conveyor bands	
disinfection of surfaces	
disinfection of packaging material	
installation within air ducts	

dimensioning	
speed of the conveyor band	number PURION UV-Modules 1400
0,0 - 0,5 m/s	1
0,5 - 1,0 m/s	2
1,0 - 1,5 m/s	3
1,5 - 2,0 m/s	4

product line	PURION UV-Module 1400	
disinfection performance:	distance of 50 mm	200 J/m ²
	distance of 500 mm	60 J/m ²
band width	1000 - 1400 mm	
dimension (L x B x H in mm)	1500 x 1000 x 100	
configuration options	Operating Time Counter (OTC-main alarm), splinter protection	
number of lamps	16	
number of electronic control cabinet Model 1	2	
life time of lamps	10.000 h	
electrical connection	3~/N/PE-50/60 Hz 230/400 V	
total power	16x 90 W	
over current protection	3x 6 A	

CONFIGURATION ELECTRIC CONTROL CABINET: Steel powder-coated

article number: 163 02500 0000
article number: 163 02600 0000

splinter protection
Operating Time Counter

-

article number: 163 02700 0000
article number: 163 02800 0000

splinter protection
Operating Time Counter

-
-

CONFIGURATION ELECTRIC CONTROL CABINET: stainless steel

article number: 163 02900 0000
article number: 163 03000 0000

splinter protection
Operating Time Counter

-

article number: 163 03100 0000
article number: 163 03200 0000

splinter protection
Operating Time Counter

-
-

equipment PURION UV-Module 1400

PURION UV-lamp 90 W
article number: 200 00600 0000



service-kit
article number: 292 00900 0000



AIRPURION 10 hum X short spl



The UV-plant AIRPURION 10 hum X short spl with an irradiation width of 130 mm consists of a matt anodized aluminium profile with matching cover sheets.

The radiator's compartment is designed for housing a pristine-polished aluminium reflector. On its rear side the cabling as well as the electronic cut-in unit is integrated into the housing.

applications	product line	AIRPURION 10 hum X short spl	
disinfection of conveyor bands	disinfection of surfaces	depends on construction conditions and the microorganism to be inactivated	
medical technology			
laboratories		irradiation width	130 mm
ripening rooms		dimension (L x B x H in mm)	300 x 67 x 100
	weight	2,0 kg	
	life time of lamps	10.000 h	
	number of lamps	1	
	protection grade	IP 54	
	electrical connection	230 V / 50 Hz or 110-240 V 50/60 Hz, 24 V DC	
	total power	10 W	
	over current protection	10 A	

advantages
chemical free approach
not affecting smell or taste
low-maintenance operation
low operational costs

alternating current (VAC)

alternating current AC
 wide voltage
 splinter protection
 dry room
 humid room

article number: 161 00300 0000
 article number: 161 00600 0000

direct current (VAC)

direct current 12 V DC
 direct current 24 V DC
 splinter protection
 dry room
 humid room

article number: 161 00700 0000

equipment AIRPURION 10 hum X short spl

AIRPURION wire suspension
 article number: 160 00011 0000



AIRPURION mounting rack
 article number: 160 00040 0000

PURION UV-lamp 10 W
 article number: 200 01300 0000



service-kit
 article number: 292 00900 0000



AIRPURION 14 hum X short spl



The UV-plant AIRPURION 14 hum X short spl with an irradiation width of 200 mm consists of a matt anodized aluminium profile with matching cover sheets.

The radiator's compartment is designed for housing a pristine-polished aluminium reflector. On its rear side the cabling as well as the electronic cut-in unit is integrated into the housing.

applications	product line	AIRPURION 14 hum X short spl	
disinfection of conveyor bands	disinfection of surfaces	depends on construction conditions and the microorganism to be inactivated	
medical technology		irradiation width	200 mm
laboratories		dimension (L x B x H in mm)	370 x 67 x 100
ripening rooms		weight	2,0 kg
	life time of lamps	10.000 h	
	number of lamps	1	
	protection grade	IP 54	
	electrical connection	230 V / 50 Hz or 110-240 V 50/60 Hz, 24 V DC	
	total power	14 W	
	over current protection	10 A	

advantages
chemical free approach
not affecting smell or taste
low-maintenance operation
low operational costs

alternating current (VAC)



article number: 161 00400 0000
 article number: 161 00800 0000

alternating current AC	wide voltage	splinter protection	dry room	humid room
•	•	•	•	•
•	•	•	•	•

direct current (VAC)



article number: 161 00900 0000

direct current 12 VDC	direct current 24 VDC	splinter protection	dry room	humid room
•	•	•	•	•
•	•	•	•	•

equipment AIRPURION 14 hum X short spl

AIRPURION wire suspension
 article number: 160 00011 0000



AIRPURION mounting rack
 article number: 160 00040 0000

PURION UV-lamp 14 W
 article number: 200 01500 0000



service-kit
 article number: 292 00900 0000

AIRPURION 17 hum X short spl



The UV-plant AIRPURION 17 hum X short spl with an irradiation width of 290 mm consists of a matt anodized aluminium profile with matching cover sheets.

The radiator's compartment is designed for housing a pristine-polished aluminium reflector. On its rear side the cabling as well as the electronic cut-in unit is integrated into the housing.

applications	product line	AIRPURION 17 hum X short spl
disinfection of conveyor bands	disinfection of surfaces	depends on construction conditions and the microorganism to be inactivated
medical technology		
laboratories		
ripening rooms		
	irradiation width	290 mm
	dimension (L x B x H in mm)	470 x 67 x 100
	weight	2,0 kg
	life time of lamps	10.000 h
	number of lamps	1
	protection grade	IP 54
	electrical connection	230 V / 50 Hz or 110-240 V 50/60 Hz, 24 V DC
	total power	17 W
	over current protection	10 A

advantages
chemical free approach
not affecting smell or taste
low-maintenance operation
low operational costs

alternating current (VAC)

alternating current AC	wide voltage	splinter protection	dry room	humid room
article number: 161 00500 0000	•	•	•	•
article number: 161 01000 0000	•	•	•	•

direct current (VAC)

direct current 12 V DC	direct current 24 V DC	splinter protection	dry room	humid room
article number: 161 01100 0000	•	•	•	•

equipment AIRPURION 17 hum X short spl

AIRPURION wire suspension
article number: 160 00011 0000



AIRPURION mounting rack
article number: 160 00040 0000

PURION UV-lamp 17 W
article number: 200 00300 0000



service-kit
article number: 292 00900 0000



AIRPURION 42 hum X short spl



The UV-plant AIRPURION 42 hum X short spl with an irradiation width of 290 mm consists of a matt anodized aluminium profile with matching cover sheets.

The radiator's compartment is designed for housing a pristine-polished aluminium reflector. On its rear side the cabling as well as the electronic cut-in unit is integrated into the housing.

applications	product line	AIRPURION 42 hum X short spl
disinfection of conveyor bands	disinfection of surfaces	depends on construction conditions and the microorganism to be inactivated
medical technology	irradiation width	290 mm
laboratories	dimension (L x B x H in mm)	470 x 67 x 100
ripening rooms	weight	2,0 kg
	life time of lamps	8.000 h
	number of lamps	1
	protection grade	IP 54
	electrical connection	110-240 V 50/60 Hz
	total power	42 W
	over current protection	10 A

advantages
chemical free approach
not affecting smell or taste
low-maintenance operation
low operational costs

alternating current (VAC)

article number: 161 00200 0000

- alternating current AC
- wide voltage
- splinter protection
- dry room
- humid room

AIRPURION wire suspension
article number: 160 00011 0000



AIRPURION mounting rack
article number: 160 00040 0000

equipment AIRPURION 42 hum X short spl

PURION UV-lamp 42 W
article number: 200 01700 0000



service-kit
article number: 292 00900 0000



AIRPURION 42 hum X midi spl



The UV-plant AIRPURION 42 hum X midi spl with an irradiation width of 290 mm has been developed especially for the integration in machineries and conveyor band systems. Due to the very compact design the required space for installation is very small.

applications	product line	AIRPURION 42 hum X midi spl
disinfection of conveyor bands	disinfection of surfaces	depends on construction conditions and the microorganism to be inactivated
medical technology		
laboratories		
ripening rooms	irradiation width	290 mm
	dimension (L x B x H in mm)	493 x 70 x 58
	weight	1,3 kg
	life time of lamps	8.000 h
	number of lamps	1
	protection grade	IP 54
	electrical connection	110-240 V 50/60 Hz
	total power	42 W
	over current protection	10 A

advantages

chemical free approach

not affecting smell or taste

low-maintenance operation

low operational costs

alternating current (VAC)



article number: 161 01200 0000

- alternating current AC
- wide voltage
- splinter protection
- dry room
- humid room

equipment AIRPURION 42 hum X midi spl

AIRPURION wire suspension
article number: 160 00011 0000



AIRPURION mounting rack
article number: 160 00040 0000

PURION UV-lamp 42 W
article number: 200 01700 0000



service-kit
article number: 292 00900 0000



equipment

Spare parts



PURION guarantees that essential equipment and spare parts are promptly delivered.

The optional equipment for the PURION UV-plants can expand possible applications. This is especially valid for the pre filtration options in the field of treatment of water.

Moreover the optional equipment for assembly makes it very easy to install the PURION plants and put them into operation.

Important spare parts e.g. PURION UV-lamps or filter cartridges are always at stock. Therefore it is ensured that even in a “emergency situation” the application is only interrupted for a very short period of time.

PURION guarantees that essential equipment and spare parts are promptly delivered.

PURION UV-lamps









PURION low pressure UV Lamps are working without generating OZONE. They emit UV C radiation at a wave-length of 254 nm.



The guaranteed life time is valid in case of not exceeded 6 switching operations of the UV-lamp per day (in average). For temperatures above 40 C° special PURION UV-lamps that are operating with Amalgam technology are available.

advantages	product line	PURION UV-lamps
germs cannot become resistant to UV C radiation	total power	10 W – 106 W
PURION UV-lamps do not produce OZONE	lamp current	425 mA – 1,2 A
A special coating on the UV-lamps glass guarantees a stable UVC-radiation	lamp voltage	25 V – 88 V
low operational costs	life time of lamps	10.000 h / 8.000 h
special options for temperatures up to 90 C°	diameter	15 mm
PURION electronic ballasts are technically coordinated with the PURION UV-lamps	length (without pin)	212 mm – 843 mm
	length pin	7,7 mm
	temperatures	-20 C° up to 90 C°



PURION UV-lamps - HIGH OUTPUT

 PURION UV-lamp 10 W article-no.: 200 01300 0000	• Temperature up to 40 C° Temperature up to 90 C° UVA-light Bio Vital	 PURION UV-lamp 14 W article-no.: 200 01500 0000	• Temperature up to 40 C° Temperature up to 90 C° UVA-light Bio Vital
 PURION UV-lamp 17 W article-no.: 200 00300 0000	• Temperature up to 40 C° Temperature up to 90 C° UVA-light Bio Vital	 PURION UV-lamp 36 W article-no.: 200 00400 0000	• Temperature up to 40 C° Temperature up to 90 C° UVA-light Bio Vital
 PURION UV-lamp 48 W article-no.: 200 00500 0000	• Temperature up to 40 C° Temperature up to 90 C° UVA-light Bio Vital	 PURION UV-lamp 90 W article-no.: 200 00600 0000	• Temperature up to 40 C° Temperature up to 90 C° UVA-light Bio Vital

PURION UV-lamps - AMALGAM TECHNOLOGY

 PURION UV-lamp 42 W article-no.: 200 01700 0000	• Temperature up to 40 C° Temperature up to 90 C° UVA-light Bio Vital	 PURION UV-lamp 106 W article-no.: 200 00800 0000	• Temperature up to 40 C° Temperature up to 90 C° UVA-light Bio Vital
-------------------------------------------------------------------------------------------------------------------------------------------	--------------------------------------------------------------------------------	---------------------------------------------------------------------------------------------------------------------------------------------	--------------------------------------------------------------------------------

SPECIAL OPTIONS

 UVA-lamp 6 W article-no.: 200 02000 0000	• Temperature up to 40 C° Temperature up to 90 C° UVA-light Bio Vital	 Bio Vital lamp 39 W article-no.: 200 01900 0000	• Temperature up to 40 C° Temperature up to 90 C° UVA-light Bio Vital
------------------------------------------------------------------------------------------------------------------------------------	--------------------------------------------------------------------------------	--------------------------------------------------------------------------------------------------------------------------------------------	--------------------------------------------------------------------------------

Hints regarding PURION UV-lamps

PURION low pressure UV Lamps are working without generating OZONE. They emit UV C radiation at a wavelength of 254 nm. At this wavelength UV radiation is most effective against bacterias, viruses and spores.

A special coating on the inside of the lamp tube guarantees stable UV C radiation. The lamp's glass serves as a filter for UV radiation < 240 nm.

At the end of the guaranteed life time PURION UV Lamps emit at least 60% of the initial UV C radiation intensity.

advantages

- germs and bacterias cannot become resistant to UV C radiation,
- PURION UV Lamps do not generate OZONE,
- disinfection by means of PURION UV Lamps implies low costs compared to chemical methods.

For the optimal operation of PURION UV lamps the correct handling and maintenance is essential. The following rules should be considered:

- It is unfavorable for the life span if the PURION UV lamp is switched very often. Every switch on reduces the life time approx. 1/2 h - 1 h.
Therefore: please only switch of the PURION UV-lamps if the expected interruption of operation is at least 30 minutes.
- The PURION UV-lamps should not be touched with fingers at the quartz made tube.
Sweat of the hand is very aggressive against quartz and causes re-crystallization (cloudiness).
If a PURION UV-lamp has been touched it is necessary to clean it with the PURION Service Kit.

Considering of this points ensures that the UV lamp reaches it's maximum life time.

The guaranteed life time of operation is valid in case of not exceeding 6 switching operations of the UV lamp per day (in average). To keep the warranty valid the PURION UV Lamps needs to be operated with PURION electronic ballasts.

Caution

During operation of PURION UV-lamps regulation and official guidelines have to be considered!

UV radiation is dangerous for human skin and eyes! Eyes and skin have to be appropriately protected. The user will be responsible for his own safety, as well as for the safety of people who are staying in areas where these radiation is used!

Please bear in mind that materials which are not UVC resistant may be damaged!

PURION immersion tube systems for reactors

The PURION immersion tube systems for reactors consists of a head made from stainless steel and a special quartz glass that allows for transmittance of UVC light. Optionally configurations as PRO systems or with Splinter Protection are available.

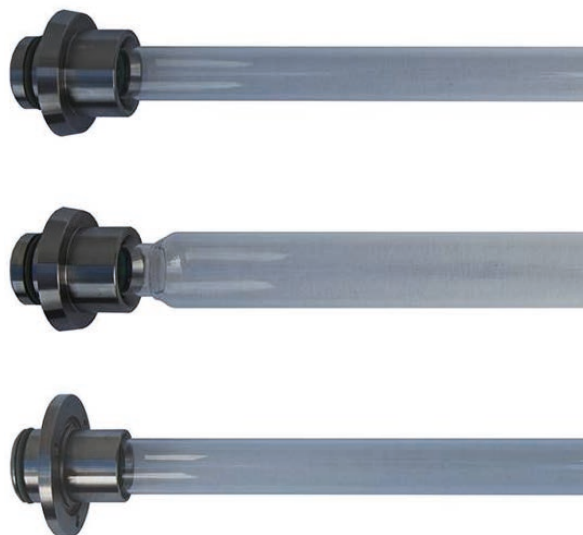

PURION Immersion tube systems for reactors made from stainless steel



Immersion tube system length 229 mm
article-no.: 104 00201 0000

reactor	standard	PRO
•		



Immersion tube system length 312 mm
article-no.: 105 00201 0000
article-no.: 105 00203 0000

reactor	standard	PRO
•	•	
•		•



Immersion tube system length 412 mm
article-no.: 110 00201 0000
article-no.: 110 00203 0000

reactor	standard	PRO
•	•	
•		•



Immersion tube system length 570 mm
article-no.: 120 00201 0000

reactor	standard	PRO
•		



Immersion tube system length 920 mm
article-no.: 130 00201 0000
article-no.: 130 00202 0000

reactor	standard	PRO
•	•	
•		•

PURION Immersion tube systems for reactors made from PVC-U



Immersion tube system length 412 mm
article-no.: 110 00202 0000

reactor	standard	PRO
•		



Immersion tube system length 570 mm
article-no.: 120 00202 0000

reactor	standard	PRO
•		



Immersion tube system length 920 mm
article-no.: 130 00204 0000

reactor	standard	PRO
•		

PURION immersion tube systems for UV-Sets

The PURION immersion tube systems for UV-Sets consists of a head made from stainless steel and a special quartz glass that allows for transmittance of UVC light. Optionally configurations with Safety Basket or with Splinter Protection are available.

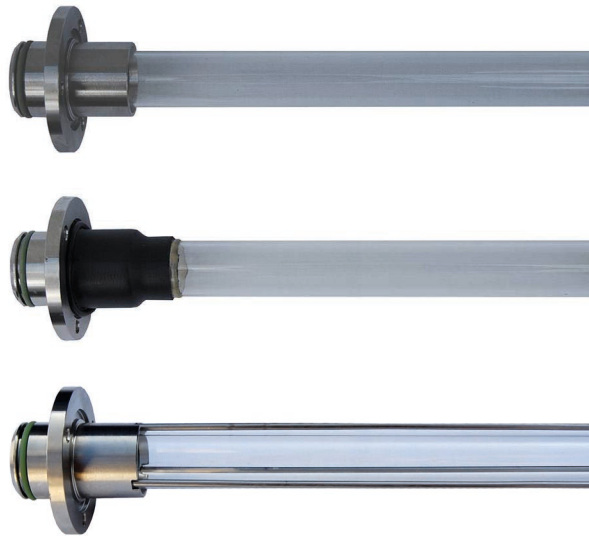

PURION Immersion tube systems for UV-Sets without Splinter Protection



Immersion tube system length 229 mm
article-no.: 104 00203 0000

- | | | |
|--------|---------------------|---------------|
| UV-Set | Splinter Protection | Safety Basket |
| • | | |



Immersion tube system length 312 mm
article-no.: 105 00202 0000

- | | | |
|--------|---------------------|---------------|
| UV-Set | Splinter Protection | Safety Basket |
| • | | |



Immersion tube system length 412 mm
article-no.: 110 00202 0000

- | | | |
|--------|---------------------|---------------|
| UV-Set | Splinter Protection | Safety Basket |
| • | | |



Immersion tube system length 570 mm
article-no.: 120 00202 0000

- | | | |
|--------|---------------------|---------------|
| UV-Set | Splinter Protection | Safety Basket |
| • | | |



Immersion tube system length 920 mm
article-no.: 130 00204 0000

- | | | |
|--------|---------------------|---------------|
| UV-Set | Splinter Protection | Safety Basket |
| • | | |

PURION Immersion tube systems for UV-Sets with Splinter Protection



Immersion tube systems length 229 mm
article-no.: 104 00204 0000

- | | | |
|--------|---------------------|---------------|
| UV-Set | Splinter Protection | Safety Basket |
| • | • | |



Immersion tube system length 312 mm
article-no.: 105 00204 0000

- | | | |
|--------|---------------------|---------------|
| UV-Set | Splinter Protection | Safety Basket |
| • | • | |



Immersion tube system length 412 mm
article-no.: 110 00205 0000

- | | | |
|--------|---------------------|---------------|
| UV-Set | Splinter Protection | Safety Basket |
| • | • | |



Immersion tube system length 570 mm
article-no.: 120 00204 0000

- | | | |
|--------|---------------------|---------------|
| UV-Set | Splinter Protection | Safety Basket |
| • | • | |



Immersion tube system length 920 mm
article-no.: 130 00206 0000

- | | | |
|--------|---------------------|---------------|
| UV-Set | Splinter Protection | Safety Basket |
| • | • | |

PURION Immersion tube systems for UV-Sets with Safety Basket



Immersion tube system length 920 mm
article-no.: 130 00209 0000

- | | | |
|--------|---------------------|---------------|
| UV-Set | Splinter Protection | Safety Basket |
| • | | • |

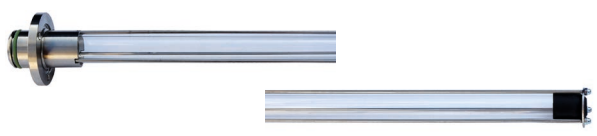

PURION UV lamp cables

PURION UV lamp cable 1,50 m
article-no.: 250 01500 0000



PURION UV lamp cable 3 m
article-no.: 250 02800 0000



PURION UV lamp cable 5 m
article-no.: 250 04300 0000



PURION UV lamp cable 10 m
article-no.: 250 09600 0000



PURION assembly systems



PURION assembly systems allow for a convenient installation of the PURION UV-lamps. Several configurations are available for different applications.

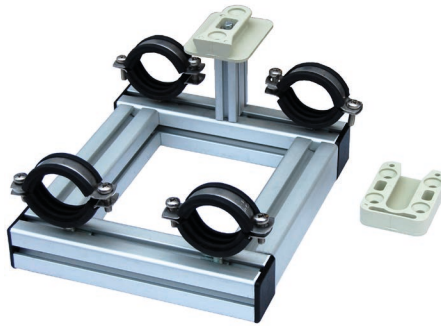

PURION assembly system



PURION assembly system
Single 1
article-no.: 290 11000 0000
article-no.: 290 10900 0000

- | | |
|---|--------------------------------|
| • | stainless steel |
| • | galvanized |
| • | assembly system for switch box |
| • | assembly system for Reactor |



PURION assembly system
Single 2
article-no.: 290 11200 0000
article-no.: 290 11100 0000

- | | |
|---|--------------------------------|
| • | stainless steel |
| • | galvanized |
| • | assembly system for switch box |
| • | assembly system for Reactor |

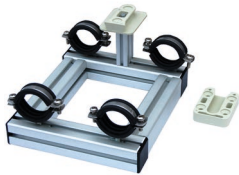

PURION assembly system
Dual 1
article-no.: 290 11400 0000
article-no.: 290 11300 0000

- | | |
|---|--------------------------------|
| • | stainless steel |
| • | galvanized |
| • | assembly system for switch box |
| • | assembly system for Reactor |

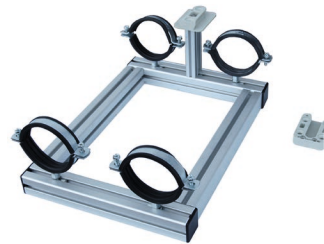

PURION assembly system
Dual 2
article-no.: 290 11600 0000
article-no.: 290 11500 0000

- | | |
|---|--------------------------------|
| • | stainless steel |
| • | galvanized |
| • | assembly system for switch box |
| • | assembly system for Reactor |

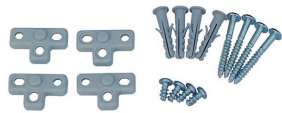

PURION assembly system switch box
article-no.: 290 12100 0000

- | | |
|---|--------------------------------|
| • | assembly system for switch box |
| • | assembly system for Reactor |

AIRPURION assembly system



AIRPURION wire suspension
article-no.: 160 00011 0000

- | | |
|---|-----------------------------------------|
| • | ceiling suspension with variable height |
| • | direct ceiling suspension |



AIRPURION mounting rack
article-no.: 160 00040 0000

- | | |
|---|-----------------------------------------|
| • | ceiling suspension with variable height |
| • | direct ceiling suspension |

filters

for treatment of water



Combination of filters to supplement the PURION UV plants enable the complete recycling of the water combined with a compact construction design and efficient energy consumption. The replacement of the filter cartridges is to be reviewed at least on annual basis. On request the different filters will be provided pre assembled.

advantages	product line	filter as additional equipment for PURION UV-plants
compact design	height	335 mm
robust construction	diameter	135 mm
low energy consumption	configuration	pre filter 60 µm fine filter 20 µm activated carbon filter de-ironing filter softener
easy replacement of cartridges	connection	1" inside thread
low investment costs	working pressure	8 bar max.
low operational costs	temperature	0 - 50 C°



filter housing 10" x 2,5"
article-no.: 410 01400 0001

filter housing
cartridge

The PURION UV plant needs to be installed behind the last filter the water flows through. Herewith disinfection of the water close to the sampling point is ensured.



cartridge 60 µm
article-no.: 410 00800 0000

filter housing
cartridge



cartridge 20 µm
article-no.: 410 00900 0000

filter housing
cartridge



cartridge activated carbon
article-no.: 410 01000 0000

filter housing
cartridge



cartridge de-ironing
article-no.: 410 04000 0000

filter housing
cartridge



cartridge softener
article-no.: 410 03900 0000

filter housing
cartridge

filter

for treatment of water



Combination of filters to supplement the PURION UV plants enable the complete recycling of the water combined with a compact construction design and efficient energy consumption. The replacement of the filter cartridges is to be reviewed at least on annual basis. On request the different filters will be provided pre assembled.

advantages	product line filter as additional equipment for PURION UV-plants	
compact design	height	335 mm
robust construction	diameter	180 mm
low energy consumption	configuration	pre filter 60 µm fine filter 20 µm activated carbon filter
easy replacement of cartridges	connection	1" inside thread
low investment costs	working pressure	8 bar max.
low operational costs	temperature	0 - 50 C°



Filter housing 10" x 4,5"
article-no.: 410 05000 0000

filter housing
•
Cartridge

The PURION UV plant needs to be installed behind the last filter the water flows through. Herewith disinfection of the water close to the sampling point is ensured.



cartridge 60 µm
article-no.: 410 05100 0000

filter housing
•
cartridge



cartridge 20 µm
article-no.: 410 05200 0000

filter housing
•
cartridge



cartridge activated carbon
article-no.: 410 05300 0000

filter housing
•
cartridge

maintenance support / others

PURION UV-safety goggles
article-no.: 292 00700 0000



UVC-light is dangerous for the human eye. The PURION safety goggles effectively protect the eyes against the UVC radiation. The visible part of the light is not retained.

Especially during operation of the PURION UV Sets or the AIR-PURION product line it is important to protect the eyes.

PURION Service KIT
article-no.: 292 00900 0000



The PURION Service KIT enables a reliable and convenient cleaning of the immersion tube system. Cleaning should be carried out latest when the UV lamp is replaced at the end of the lifetime or if operation conditions require it.

The special cleaning tissues made from 100% cotton guarantee that the sensitive quartz glass is not damaged by scratches during the cleaning procedure.

The cleaning solution ensures that after the cleaning no residues of soap can lead to foam formation. Therefore the PURION Service KIT is suitable to drinking water applications.

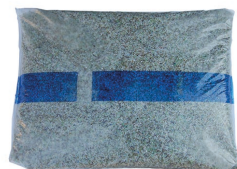

PURION Quartz-granulate
article-no.: 292 02300 0000
article-no.: 292 02400 0000

• fine grain
• rough grain

The PURION filter granulates made from special quartz is applied within the PURION Pool plants.

The Quartz-granulate is available with rough grain and fine grain. Therefore sediments are removed very efficiently from the circulation water before the UV based disinfection is carried out.

The Quartz-granulate can be flushed out from filtrated sediments very easy during backwash procedure.

Company

with TRADITION & INNOVATION



The PURION® GmbH is a European company with a global focus. Our future-oriented and ecologically friendly methods help to improve a worth living environment.

PURION® GmbH is member of the BMBF-program „Twenty20 - Partnership for Innovation“, „Research Regarding UV-LED-Light for Innovative Applications within Health Care, Water Treatment, Production Technology and Sensor Technology“. Highly reputable German research institutions are co-operation partners within this program.

PURION® GmbH is partner of the cooperation's network HySic – Hygienic Safety. The aim is to develop and to realize solutions for the improvement of the hygienic safety in different important applications.



To ensure compliance with high quality standards production and management processes of PURION GmbH are established in line with the certified standard management system DIN EN ISO 9001:2015. The certification is renewed annually.



PURION GmbH

Schubertstraße 18
98544 Zella-Mehlis
Germany

T: +49 (0)3682 / 479087
F: +49 (0)3682 / 479086
E: uv-technology@purion.de
H: www.purion.eu



I. General terms of the contract

The Customer has notice of the following general conditions for sales and supplies. The Customer agrees with the fact that following general conditions are essential elements of contracts concluded between the Customer and the Supplier.

II. Scope of supplies and services

1. The scope of any supplies or services effected hereunder shall be governed by the written statements supplied by the two parties. If a contract is concluded and the parties have failed to make any such statements, then either the Supplier's or the Service Provider's (hereinafter referred to as »Supplier«) written order confirmation, or, failing such, the written order from the Customer shall be binding.
2. For all supplies or services, the provisions stipulated by the Verband Deutscher Elektrotechniker (= Association of German Electro-technical Engineers) shall be applied as far as they are relevant for the safety of the supplies and services. Variations are allowed if the same safety standard is ensured by other means.
3. The Supplier reserves the unrestricted right of ownership and the copyrights to all quotations, drawings, and other documentation; they shall be made available to third parties only if prior written approval from the Supplier has been obtained.
4. The scope of the delivery shall be as indicated in the written order confirmation from the Supplier. If such confirmation is not available, the delivery note shall be considered the order confirmation.
5. Any verbal collateral agreement shall be effective only if confirmed in writing.

III. Price

The prices are understood net, plus V.A.T. as provided by law. They are valid ex works, exclusive of packaging, freight charges, postage, insurance, and other additional expenses. Samples or similar preparatory work occasioned by the Customer will be charged for even if the contract is not awarded.

IV. Reservation of title

The goods remain the property of the Supplier until all claims he may have vis-a-vis the Customer as a result of the said business transaction are satisfied. Prior to this, any pledging or transfer of ownership by way of security is not allowed, and reselling is only permitted for resellers in the normal course of business under the proviso that the reseller receives payment from his customer. Any costs incurred in connection with interventions shall be borne by the Customer.

V. Terms of payment

1. The payments shall be effected free place of payment of the Supplier.
2. The Customer may effect set-offs only against undisputed or legally established debts.
3. In case of non-observance of payment terms, or if reasonable doubts in respect of the credit-worthiness of the Customer exist, the Supplier has the right to request advance payments and other payments for all outstanding accounts and even for those accounts that are not yet due, have any unpaid deliveries returned at the Customer's expenses, or withdraw from the contract without notice.

VI. Time allowed for deliveries and services

1. Delivery times/deadlines shall only be binding if expressly approved by the Supplier in writing. Compliance with the deadlines can only be assured if the Customer has fulfilled all of its contractual obligations and/or has effected any agreed advance payments and/or has met any other duty he may have in respect of prior performance or cooperation. Another prerequisite for observance of the deadlines is the correct and on-time delivery by the suppliers of the Supplier as far as the Supplier has selected them with due care and in a business-like manner.
2. The deadline is considered met if the ready-for-use consignment was dispatched or collected within the time specified for delivery or performance. In case of delayed delivery due to Customer's fault, the deadline is considered met if the information of readiness for dispatch was given within the agreed period of time.
3. If proof can be furnished that non-observance of the deadline for the deliveries and services happened because of mobilization, war, riot, strike, acts of the authorities, or occurrence of unpredictable circumstances, the time shall be reasonably extended.
4. The same holds if Sub-Contractors are affected by these circumstances.
5. If the Supplier is in default, and if an additional period of time granted by the Customer has lapsed without any response on the part of the Supplier, the Customer has the right to withdraw from contract. Damages for non-performance cannot be claimed unless the default occurred as a result of the Suppliers' wrongful intent or gross negligence.
6. In case dispatch or delivery of the goods are delayed on request of the Customer, then, beginning one month after the date of advice of readiness for shipment, a storage fee amounting to ½ % of the invoice amount can be charged to the Customer for any commenced month; such storage fee, however, shall be limited to 5% unless proof of higher costs is furnished.
7. In case of orders for goods to be delivered on demand, the call time for the overall order shall be one year from the date of confirmation by the Supplier. The Customer agrees to inform about his forthcoming request not later than four production weeks in advance. If the Customer fails to demand the full quantity until expiration of the time specified, the Supplier may, after prior notice, opt for performance or withdraw from the contract. Claims for damages, if any, shall not be affected.

VII. Passing of the risk

1. Upon delivery of the goods to the carrier company, the risk will pass to the Customer, even if delivery on carriage paid basis or self-collection had been agreed upon, or the ready-for-use consignment was dispatched or collected.
2. In the absence of other agreements, the Supplier is free to choose the kind of packaging, the routing, and the mode of dispatch. The costs for packaging shall be borne by the Customer.
3. The packaging will be effected with best care, the dispatch will be effected to the Supplier's best discretion. At the Customer's request and expenses, the Supplier will insure the consignment against damage by breakage, transport damage, and fire damage.
4. In case the dispatch or delivery of the goods is delayed on request of the Customer or for reasons lying with him, then the risk shall pass on to him for the time of the delay. The Supplier, however, undertakes to effect the insurances required by the Customer at the Customer's request and expenses.

VIII. Acceptance

1. Delivered items have to be accepted by the Customer, even if those items show minor shortcomings.
2. Partial deliveries are allowed.

IX. Liability for defects

For any defects, including the absence of warranted qualities, the Supplier shall be liable as follows:

1. All parts or services which - within a period of 24 months from the date of the passing of the risk, irrespective of their operating time - become unuseable as a consequence of any circumstances that have existed already prior to the time of the passing of the risk, i.e. in particular, due to defective design, faulty material, or faulty workmanship, or whose useability is considerably impaired, shall, at the Supplier's option and at no cost, either be repaired or replaced by new items or be provided again.
Any such defects found shall be promptly notified to the Supplier in writing; the goods shall be sent to the Supplier for examination.
2. The Customer affords the Supplier the opportunity and grants it such reasonable period of time as necessary to remedy the defects. If he fails to do so, the Supplier shall be exempt from the liability for defects.
3. In case the Supplier fails to remedy the defect within the additional period of time granted to him, the Customer may require the contract to be cancelled (exchange) or request reduction of the price (diminution).
4. The Customer agrees to fulfill all his contractual obligations, i.e. in particular regarding the agreed Terms of Payment. In case a notification of defects is put forward, then payments from the Customer may be withheld to an amount reasonably proportionate to the defects found.
5. The liability for defects does not include normal wear as well as any defects developing after the passing of the risk as a result of faulty or negligent handling, due to non-observance of specifications issued by the Supplier, excessive use, unsuitable production equipment, and such influences of a chemical, electrochemical or electrical nature which are not expressly provided for in the contract; not included are also defects attributable to the use of material supplied by the Customer.
6. Any changes or repairs performed in an improper manner by the Customer or third parties without the prior consent from the Supplier will void any liability for the consequences resulting from this.
7. The warranty period shall be 3 months for remedied items, and six months for replacement deliveries. It runs, at least, until the end of the original warranty period for the delivered item. The duration of the warranty period for defects shall be extended by the duration of the downtime necessary for such remedying, replacement deliveries or services.
8. The provisions regarding warranty periods under 1. and 7. shall not apply as far as longer periods are provided for by law.
9. Any further claims of the Customer vis-a-vis the Supplier and the Supplier's agents shall be excluded, in particular claims because of damages not to the delivery item proper. This shall not apply as far as either liability to the Product Liability Act, e.g. for personal injuries and damages to objects of private use, or compulsory liability in cases of wrongful intent, gross negligence, or absence of warranted qualities, is invoked.
10. The Articles 1. through 9. shall also apply to any right to claim corrective work, replacement delivery or damages the Customer may have as a result of advice or consultation provided under the contract, or due to breach of additional contractual obligations.

X. Impossibility of performance, adjustment of contract

If it should be impossible for the Supplier or the Customer to effect the agreed supplies or services, then the general legal principles shall apply as follows:

The Customer is authorized to claim damages from the Supplier in case of premeditation or gross negligence. Such damages, however, shall be limited to 10% of the value of that part of the delivery or service which cannot be put into operation as desired due to the said impossibility. Any claims for damages on the part of the Customer exceeding the said limit of 10% are excluded. This shall not apply if compulsory liability is invoked, e.g. in instances of wrongful intent or gross negligence. Nothing hereunder shall affect the Customer's right to withdraw from the contract.

Inasmuch as unforeseen circumstances to Article V, clause 3, para. 1, effect a considerable change in the economic significance or the contents of the delivery or service, or exert a major influence on the Supplier's operations, the contract shall be reasonably adapted in accordance with the requirements of good faith. As far as this proves to be in conflict with economic interests, the Supplier has the right to withdraw from the contract. If he opts to exercise this right, he shall, after he became aware of the consequences resulting from said circumstances, inform the Customer accordingly even if extension of delivery time had been agreed upon with the Customer.

XI. Other claims for damages

Claims for damages on the part of the Customer resulting from breach of contract, breach of obligations during the contract negotiations, or tort, are excluded. This shall not apply inasmuch as either liability according to the Product Liability Act, e.g. for personal injuries and damage to goods of private use, or compulsory liability for cases of wrongful intent and gross negligence, is invoked. The same limitation of liability shall also be valid for the Customer.

XII. Place of jurisdiction

1. If the Customer is a fully qualified merchant, the Supplier is free to decide if either the place of the Supplier's head office or the place of the Supplier's branch office shall be the exclusive place of jurisdiction for all direct or indirect disputes arising from the contractual relationship.
2. The contractual relationship shall be governed exclusively by German law, without any recourse to the UN Right of Purchase (CISG).

XIII. Validity of the contract

If any provision of the contract is held to be ineffective, this shall not affect and impair the validity of the other provisions. The foregoing shall not apply if adherence to the contract would constitute an unreasonable hardship for one of the parties.

WARRANTY

for PURION UV-lamps

The PURION® GmbH grants for low pressure UV lamps the following warranty:

- Basis of the decision on a warranty or replacement is the evaluation in our PURION labs. Therefore complaints need to be sent to PURION® GmbH.
- The warranty is granted for 10.000 hours of operation for PURION UV low pressure lamps and 8.000 hours for PURION UV Amalgam lamps up to maximum 2 years from the date of delivery.
- Up to 1.000 hours of operation the lamps will be fully replaced.
- Up to 10.000 hours of operation the replacement and financial compensation will be proportional referring to the operating time.
- For PURION Amalgam lamps the proportional compensation refers to the operation time of 8.000 hours.
- To keep the warranty valid the number of switching operation must not exceed an average of 5-6 per day.
- Operating time and switching operations needs to be proved with suitable measures.
- To keep the warranty valid the PURION UV lamps needs to be operated with PURION electronic ballasts.
- Breakage of glass will not be compensated.

These conditions are valid, when no other special agreement is stated. Special agreements must put down in writing.