

**PURION**<sup>®</sup>  
THE BEST SOLUTION

**AIR**   
SOLUTIONS FOR TREATMENT OF AIR

CATALOG OF PRODUCTS



## UV: DISINFECTION WITHOUT CHEMICALS

### **UVC based disinfection operating principle**

3



### **configuration options for monitoring of the PURION UV plants**

4 - 8



### **disinfection of air**

9 - 40



### **equipment spare parts**

41 - 50



### **company with tradition and innovation**

51 - 54



# Disinfection with UVC

## OPERATING PRINCIPLE

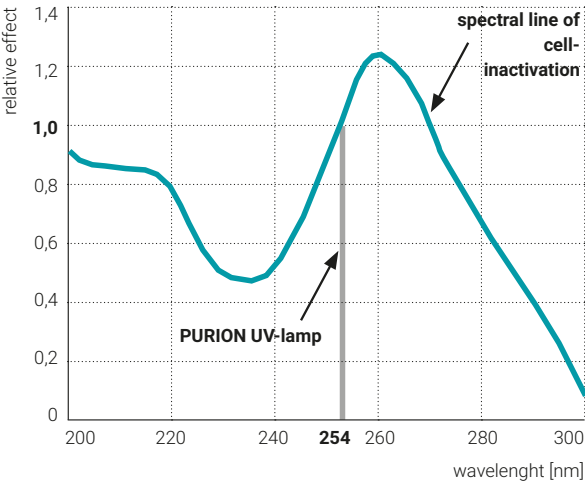
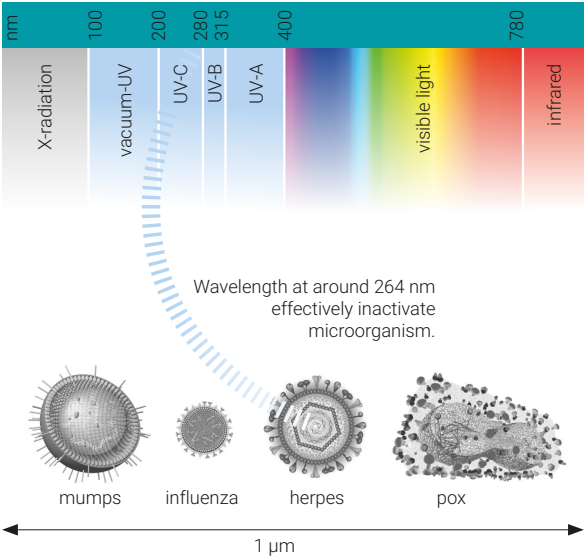

Microorganisms such as bacteria, moulds, yeasts and protozoa can be destroyed or removed by physical, biological and chemical methods.

UVC works using a photolytic effect whereby the radiation destroys or inactivates the microorganism so that it can no longer multiply. The phenomenon whereby microorganisms can be disfigured or destroyed is independent of host state (fluid or solid) and indeed pH or temperature.

Therefore disinfection of fluids, air and surfaces without using chemicals or high temperatures becomes possible in new applications.

Ultraviolet is that part of electro-magnetic radiation bounded by the lower wavelength extreme of the visible spectrum and the upper end of the X-ray radiation band. The spectral range of ultraviolet radiation is, by definition between 100 and 400 nm (1nm=10<sup>-9</sup>m) and is invisible to human eyes.

A strong germicidal effect is provided by the radiation in the short wave UVC band. The UV radiation emitted by a source is expressed in watts (W) and the irradiation density is expressed in watts per square meter (W/m<sup>2</sup>).

For germicidal action dose is important. The dose is the irradiation density multiplied by the time (t) in seconds and expressed in joules per square meter (J/m<sup>2</sup>). 1 joule is 1 watt-second.

# CONFIGURATION OPTIONS

## FOR MONITORING OF THE PURION UV-PLANTS

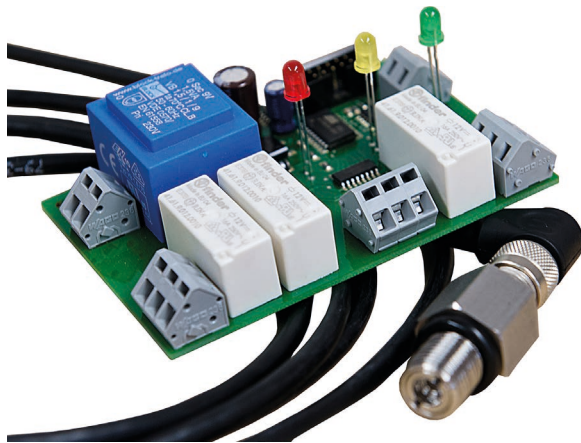

PURION guarantees disinfection for an operating time up to max. 10.000 h or max. 8.000 h for PURION UV-lamps with Amalgam technology for high ambient temperatures up to 90 C°.

After 10.000 h or 8.000 h of operation the UVC-intensity falls below 60% of the initial value. All technical performance data of the PURION UV plants have been derived from this "end of life" value.

Therefore the PURION UV-lamp has to be replaced after 10.000 h / 8.000 h.

The UVC-light that is decisive for disinfection has a wavelength of approx. 260 nm and cannot be detected by human eyes. In consequence it is not possible to determine the aging of the PURION UV-lamp without monitoring options.

Besides the basic monitoring of the operation status (control light) PURION provides several options for automatical detection and signaling of the lamps age and disinfection performance

With PURION configuration options for the monitoring of the UV plants it is guaranteed that the replacement of the UV-lamps is duly carried out.

PURION Monitoring of the UV-lamps operational time

# Operating Time Counter – OTC



The Operating Time Counter (OTC) option monitors the life time of the UV lamp via summation of the operating time. The current status is displayed via LED's.

advantages	product line	Operating Time Counter – OTC
automatic recording of the exact operating time of the PURION UV lamps	voltage supply	230 V AC or 12 V DC or 24 V DC
automatic (pre-)alarm when lamp replacement is necessary	signal input	Operating Time Coter
optional configuration with potential free contacts for the LED signals	signal output	optional: potential free contact for any LED
safe reset procedure	load potential free contacts	up to 100 mA
maintenance free operation	special function	reset after replacement of the lamp
cost efficient monitoring option	steady light (green LED)	<95% of the warranted service life
	pre-alarm (yellow LED)	>95% <100% of the warranted service life
	main-alarm (red LED)	warranted service life has been exceeded

The OTC option works as a time counter and is integrated in the control box.

The monitoring system is designed as a traffic light. Two thresholds for the operating time have been saved:

- As long as the operating time is below 95% of the guaranteed life time the green LED is illuminated.
- If the operating time exceeds 95% of the guaranteed life time the yellow LED is illuminated (pre alert).
- If the operating time exceeds the guaranteed life time the red LED is illuminated (main alert). The UV lamp has to be replaced to ensure disinfection.

It is urgently recommended to clean the immersion tube system with the PURION Service KIT at latest during replacement of the UV lamps.

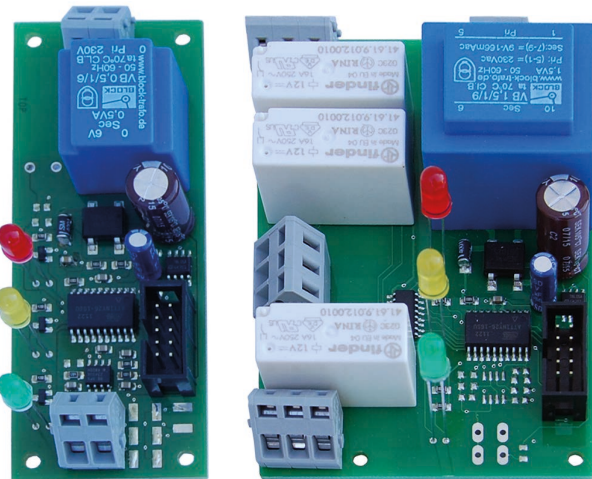

Additionally it is possible to configure the monitoring option OTC with potential free contacts for every LED. Therefore our clients are able to use information regarding the current status for additional switching operations (load potential free contact max. 100 mA).

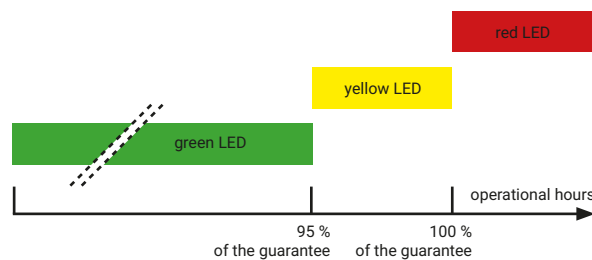

PURION Monitoring of the UVC-intensity

# Operating Power Detection – OPD



The Operating Power Detection (OPD) option monitors the life time of the UV lamp via detecting the UV intensity. The current status is displayed via LED's.

advantages	product line	Operating Power Detection – OPD
automatic recording of the exact UVC intensity that is currently used for disinfection	voltage supply	230 V AC or 12 V DC or 24 V DC
automatic (pre-)alarm when lamp replacement is necessary	signal input	SiC-UV-Sensor
optional configuration with potential free contacts for the LED signals	signal output	optional: potential free contact for any LED
safe reset procedure	load potential free contacts	up to 100 mA
maintenance free operation	special function	calibration after replacement of the lamp
cost efficient monitoring option	steady light (green LED)	>70% of the initial intensity
	pre-alarm (yellow LED)	<70% and mind. 60% of the initial intensity
	main-alarm (red LED)	<60% of the initial intensity

The OPD configuration directly detects the UVC intensity via SiC-UV-Sensor.

The monitoring system is designed as a traffic light and integrated in the control box. Two thresholds for UV intensity have been saved:

- As long as the UV intensity is more than 70% of the initial value the green LED is illuminated.
- If the UV intensity goes below 70% of the initial value the yellow LED is illuminated.
- If the UV intensity goes below 60% of the initial value the red LED is illuminated. To ensure disinfection the UV lamp has to be replaced.

It is urgently recommended to clean the immersion tube system with the PURION Service KIT at latest during replacement of the UV lamps.

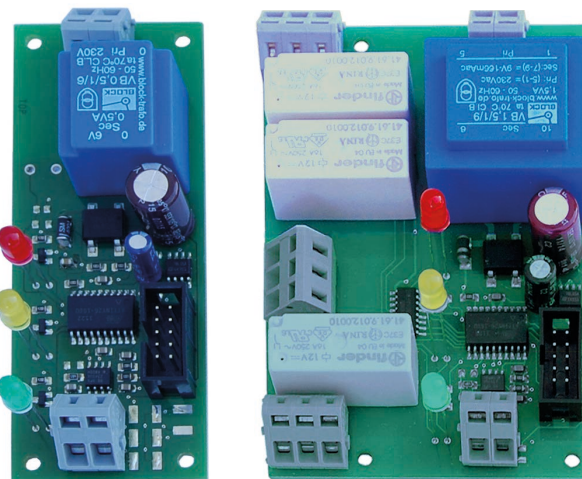

Additionally it is possible to configure the monitoring option OPD with potential free contacts for every LED. Therefore our clients are able to use information regarding the current status for additional switching operations (load potential free contact max. 100 mA).

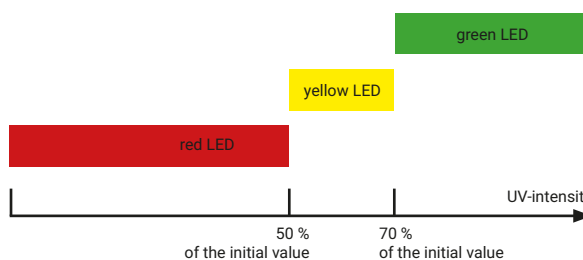

# PURION UVC Sensor

in a stainless steel housing



This sensor is suitable for monitoring of the intensity of PURION UVC low-pressure lamps, PURION UVC high-output lamps and PURION UVC amalgam lamps.

## properties of the SiC-sensor

wideband  
UVA-UVB-UVC Photodiode

optimal ability for measuring powerful UVC radiation

silicon carbide chip warrants extreme radiation power

TO-18 metallic housing - 0.054 mm<sup>2</sup> active chip surface

## product line PURION SiC Sensor

UV-intake 6 mm

angle spread approx. 30°

temperature 0°C up to 60°C

housing stainless steel 1.4571

connection flanges G ¼" SW 19

seal Viton

pressure-tight 10 bar

dimensions (L x Ø in mm) 45 x SW 19

signaling foto voltage

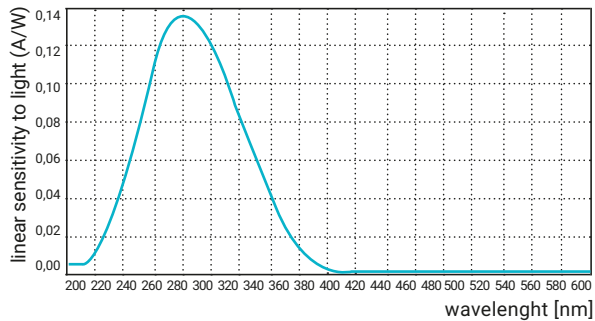

The sensor is equipped with a silicon carbide photodiode (SiC).

The photodiode has a very good sensitivity within the range of 250 and 260 nm. Therefore the diode is suitable to monitor UV light that is used for disinfection and with a peak emission rate at 254 nm.

This is in line with the DNS absorption curve.

The monitoring unit is designed as a traffic light. During monitoring the percentage of the UV intensity is evaluated.

# PURION UVC Sensor

in a stainless steel housing  
with integrated booster  
and power output



This sensor is suitable for monitoring of the intensity of PURION UVC low-pressure lamps, PURION UVC high-output lamps and PURION UVC amalgam lamps.

### properties of the SiC-sensor

wideband  
UVA-UVB-UVC Photodiode

optimal ability for measuring powerful UVC radiation

silicon carbide chip warrants extreme radiation power

TO-18 metallic housing - 0.054 mm<sup>2</sup> active chip surface

### product line PURION SiC Sensor 4-20 mA

UV-intake	6 mm
angle spread	approx. 30°
temperature	0°C up to 60°C
housing	stainless steel 1.4571
connection flanges	G 1/4" SW 19
seal	Viton
pressure-tight	10 bar
dimensions (L x Ø in mm)	67 x SW 19
power output	4-20 mA
supplied voltage	9-24 VDC
UVC-sensitivity	approx. 30 - 300 W/m <sup>2</sup>

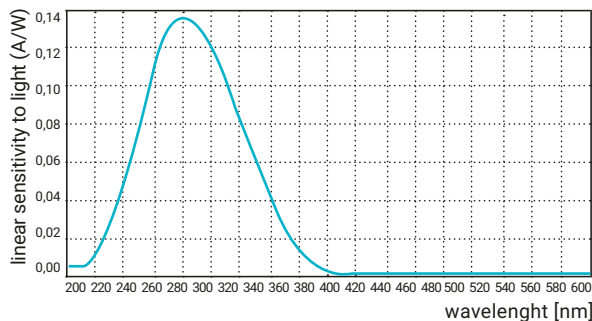

The sensor type is SiC-based and therefore only UV-sensitive (daylight blind).

High intrinsic insensibility against visible light through semiconducting material with high bandgap.

The snubber circuit of the sensor with 4...20mA enables the integration of the signal in Programmable Logic Controller (PLC) systems.

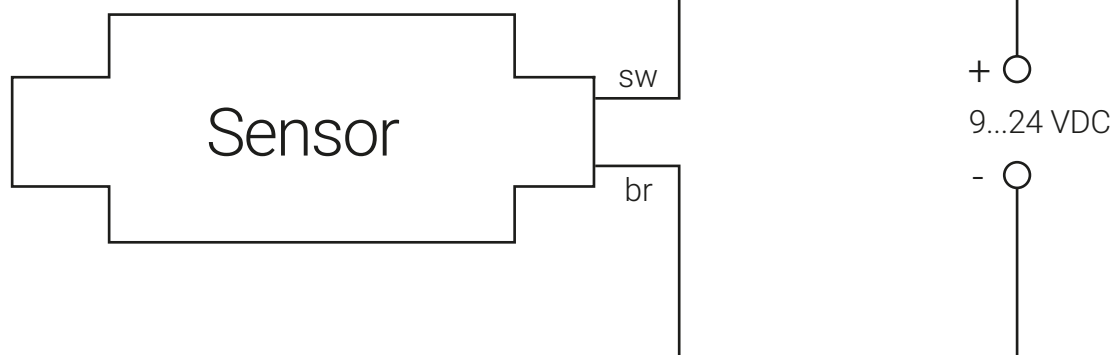



**AIRPURION-plants**

direct and indirect irradiation

10 - 15

**AIRPURION active plants**

closed systems with integrated air circulation

16 - 18

**AIRPURION DUO**

UVC-disinfection and illumination

19

**AIRPURION Sterile Fridge active**

closed systems for UVC disinfection and removal of bad odour

20

**AIRPURION-AIR processing units**

closed systems with PURION reactors

21 - 26

**PURION UV-Sets**

27 - 38

**AIRPURION mobile**

mobile UVC-disinfection

39 - 40

# dry room dry X

# humid room hum X



With AIRPURION UV-plants for dry rooms the PURION UV-lamp works directly within the room or the flow of air. Therefore maximum radiant efficiency is ensured. AIRPURION UV-plants for dry rooms are the best solution for e.g. for laboratories and clean rooms.

Depending on the constructional conditions and the kind of microorganisms to be inactivate a customized solution should be determined.

With AIRPURION UV-plants for humid rooms the PURION UV-lamp is capsuled into an immersion tube system that is protection the electronic components against humidity. Additionally the electronic ballast is integrated into a special moisture-proofed housing. Therefore it is possible to operate these AIRPURION units in humid rooms. Moreover these AIRPURION UV-plants can be equipped with a special coating as splinter protection for the immersion tube systems. For applications within the food industry it is always recommended to use AIRPURION units with splinter protection.

advantages	product line	AIRPURION dry X
low weight	irradiation width	130 – 750 mm
different options for assembly	dimension L x B x H in mm	300 x 67 x 100 up to 1000 x 67 x 100
	weight	2-5 kg
high UVC-efficiency	life time of lamps	10.000 h
additional chemicals are not required for disinfection	number of lamps	1
not affecting smell or taste	temperature max.	40°C
low-maintenance operation	protection grade	IP 54
	electrical connection	230 V/50 Hz or 110-240 V 50/60 Hz or 24 V DC
low investment costs	total power	10 W – 90 W
low operational costs	over current protection	10 A

Independently of the very high UVC transmission in case of dry rooms it is recommended to contact our technical support to determine the best solution for your application.

advantages	product line	AIRPURION hum X
operation in case of high humidity	irradiation width	130 – 750 mm
different options for assembly	dimension L x B x H in mm	300 x 67 x 100 up to 1000 x 67 x 100
	weight	2,5 - 6 kg
UVC-efficiency is not reduced by the immersion tube system	life time of lamps	10.000 h
immersion tube system can be equipped with an immersion tube system	number of lamps	1
additional chemicals are not required for disinfection	temperature max.	40°C
not affecting smell or taste	protection grade	IP 54
low-maintenance operation	electrical connection	230 V/50 Hz or 110-240 V 50/60 Hz or 24 V DC
	total power	10 W – 90 W
low operational costs	over current protection	10 A

Very high humidity leads to a decreasing UVC-transmission of the AIR. This effect and the corresponding reduction of disinfection performance has to be considered during designing a technical solution.

PURION would like to support you to determine the best solution for your application.

# Splinter Protection spl



All AIRPURION units and PURION UV Sets for disinfection of tanks and surfaces can be equipped with splinter protection.

The quartz glass is coated with a special UVC-transparent film. Therefore it is guaranteed that no glass splinters can be released when the quartz tube has been damaged.

The PURION Splinter Protection is available for the following PURION product lines:

- AIRPURION Sterile Fridge active
- AIRPURION AIR Processing units
- AIRPURION mobile
- AIRPURION
- PURION UV-Sets

The coating is restricted to the quartz tube which is the outer protection of the UV-lamp. It enables optimal use of the UVC radiation and provides a good and safe performance. The PURION UV-lamp is replaced in the usual way. The compact design enables an easy replacement without usage of additional tools at the end of the UV lamps service life.

Particularly in areas of food production the PURION splinter protection is very important.

# Safety Basket bs

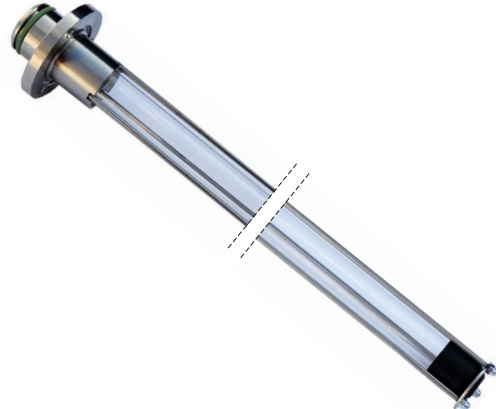

The Safety Basket for the PURION product families PURION UV-Set 36 W and PURION UV-Set 90 W enables the assembling in horizontal position and without additional thrust bearing in case of vertical installation.

The option for stabilization allows for new applications.

The PURION Safety Basket is available for the following PURION product lines:

- UV-Set PURION 36 W
- UV-Set PURION 90 W

The new safety basket consists of three support rods made from stainless steel fixed at the head of the immersion tube system. On the other side these rods are fixed at a mounting ring made from stainless steel. The safety basket does not lead to a bigger diameter compared to the head of the immersion tube system. Therefore this safety feature can be easily integrated into existing installations.

Particularly in the field of tank disinfection the PURION Safety Basket provides an optimal solution.

**Caution!**  
**UV radiation is dangerous for human skin and eyes! Eyes and skin have to be appropriately protected.**  
**The user will be responsible for his own safety, as well as for the safety of people who are staying in areas where these radiation is used. Please bear in mind that materials which are not UVC resistant may be damaged.**

# AIRPURION 17



The UV-plant AIRPURION 17 with an irradiation width of 300 mm consists of a matt anodized aluminium profile with matching cover sheets.

The radiator's compartment is designed for housing a pristine-polished aluminium reflector. On its rear side the cabling as well as the electronic cut-in unit is integrated into the housing.

applications	product line	AIRPURION 17
pharmacy	irradiation width	300 mm
medical technology	disinfection 80%	approx. 36 m <sup>3</sup>
	disinfection 88%	approx. 18 m <sup>3</sup>
laboratories	weight	2,0 kg
ripening rooms	life time of lamps	10.000 h
	dimension (L x B x H in mm)	700 x 67 x 100
	number of lamps	1
	protection grade	IP 54
	electrical connection	230/ 50 Hz or 110-240 50/60 Hz, 24 V DC
	total power	17 W
	over current protection	10 A
<b>advantages</b>		
suitable for direct or indirect irradiation		
not affecting smell or taste		
low-maintenance operation		
low operational costs		

## alternating current (VAC)

	alternating current AC	wide voltage	splinter protection	dry room	humid room
article number: 160 00900 0000	•			•	
article number: 160 04100 0000	•	•		•	

	alternating current AC	wide voltage	splinter protection	dry room	humid room
article number: 160 01000 0000	•				•
article number: 160 04200 0000	•	•			•
article number: 160 02500 0000	•		•		•
article number: 160 04300 0000	•	•	•		•

## direct current (VAC)

	direct current 12 V DC	direct current 24 V DC	splinter protection	dry room	humid room
article number: 160 00100 0000				•	
		•		•	

	direct current 12 V DC	direct current 24 V DC	splinter protection	dry room	humid room
article number: 160 04400 0000			•		•
article number: 160 04500 0000			•	•	•

## equipment AIRPURION 17

AIRPURION wire suspension  
article number: 160 00011 0000



AIRPURION mounting rack  
article number: 160 00040 0000

PURION UV-lamp 17 W  
article number: 200 00300 0000



service-kit  
article number: 292 00900 0000



# AIRPURION 36



The UV-plant AIRPURION 36 with an irradiation width of 750 mm consists of a matt anodized aluminium profile with matching cover sheets. The radiator's compartment is designed for housing a pristine-polished aluminium reflector. On its rear side the cabling as well as the electronic cut-in unit is integrated into the housing.

applications	product line	AIRPURION 36
pharmacy	irradiation width	750 mm
medical technology	disinfection 80%	approx. 53 m <sup>3</sup>
	disinfection 88%	approx. 26 m <sup>3</sup>
laboratories	weight	3,0 kg
ripening rooms	life time of lamps	10.000 h
	dimension (L x B x H in mm)	1000 x 67 x 100
	number of lamps	1
	protection grade	IP 54
	electrical connection	110-240 50/60 Hz
	total power	36 W
	over current protection	10 A
<b>advantages</b>		
suitable for direct or indirect irradiation		
not affecting smell or taste		
low-maintenance operation		
low operational costs		

## alternating current (VAC)

article number: 160 01100 0000

- | alternating current AC
- | wide voltage
- | splinter protection
- | dry room
- | humid room

article number: 160 01200 0000

article number: 160 04000 0000

- | alternating current AC
- | wide voltage
- | splinter protection
- | dry room
- | humid room

## equipment AIRPURION 36

AIRPURION wire suspension  
article number: 160 00011 0000



AIRPURION mounting rack  
article number: 160 00040 0000

PURION UV-lamp 36 W  
article number: 200 00400 0000



service-kit  
article number: 292 00900 0000



# AIRPURION 48



The UV-plant AIRPURION 48 with an irradiation width of 380 mm consists of a matt anodized aluminium profile with matching cover sheets.

The radiator's compartment is designed for housing a pristine-polished aluminium reflector. On its rear side the cabling as well as the electronic cut-in unit is integrated into the housing. The high UVC-intensity ensures an optimal degree of efficiency combined with a compact construction design.

applications	product line	AIRPURION 48
pharmacy	irradiation width	380 mm
medical technology	disinfection 80%	approx. 70 m <sup>3</sup>
	disinfection 88%	approx. 35 m <sup>3</sup>
laboratories	weight	2,0 kg
ripening rooms	life time of lamps	10.000 h
	dimension (L x B x H in mm)	700 x 67 x 100
	number of lamps	1
	protection grade	IP 54
	electrical connection	110-240 50/60 Hz
	total power	48 W
	over current protection	10 A

## advantages

suitable for direct or indirect irradiation

not affecting smell or taste

low-maintenance operation

high degree of efficiency

## alternating current (VAC)



article number: 160 01300 0000

- alternating current AC
- wide voltage
- splinter protection
- dry room
- humid room



article number: 160 01400 0000

article number: 160 03200 0000

- alternating current AC
- wide voltage
- splinter protection
- dry room
- humid room

## equipment AIRPURION 48

AIRPURION wire suspension  
article number: 160 00011 0000



AIRPURION mounting rack  
article number: 160 00040 0000

PURION UV-lamp 48 W  
article number: 200 00500 0000



service-kit  
article number: 292 00900 0000



# AIRPURION 90



The UV-plant AIRPURION 90 with an irradiation width of 750 mm consists of a matt anodized aluminium profile with matching cover sheets.

The radiator's compartment is designed for housing a pristine-polished aluminium reflector. On its rear side the cabling as well as the electronic cut-in unit is integrated into the housing. The high UVC-intensity ensures an optimal degree of efficiency combined with a compact construction design.

applications	product line	AIRPURION 90
pharmacy	irradiation width	750 mm
medical technology	disinfection 80%	approx. 100 m <sup>3</sup>
	disinfection 88%	approx. 50 m <sup>3</sup>
laboratories	weight	3,0 kg
ripening rooms	life time of lamps	10.000 h
	dimension (L x B x H in mm)	1000 x 67 x 100
	number of lamps	1
	protection grade	IP 54
	electrical connection	110-240 50/60 Hz
	total power	90 W
	over current protection	10 A

## advantages

suitable for direct or indirect irradiation

not affecting smell or taste

low-maintenance operation

high degree of efficiency

## alternating current (VAC)

article number: 160 01500 0000

- alternating current AC
- wide voltage
- splinter protection
- dry room
- humid room

article number: 160 01600 0000

article number: 160 02400 0000

- alternating current AC
- wide voltage
- splinter protection
- dry room
- humid room

## equipment AIRPURION 90

AIRPURION wire suspension  
article number: 160 00011 0000



AIRPURION mounting rack  
article number: 160 00040 0000

PURION UV-lamp 90 W  
article number: 200 00600 0000



service-kit  
article number: 292 00900 0000



# AIRPURION 48 active



The AIRPURION 48 active consists of a matt anodized and completely closed aluminium frame. Wiring system and the electronic cut-in unit are integrated into the frame.

Scope of delivery of an AIRPURION active plant also contains a mounting rack or a wire suspension for assembly.

applications	product line	AIRPURION 48 active
production or packaging of food	turnover of ambient air	24 m <sup>3</sup> /h
medical technology	disinfection 80%	approx. 300 m <sup>3</sup>
	disinfection 88%	approx. 45 m <sup>3</sup>
laboratories	weight	6,0 kg
preparation rooms in hotel kitchen	life time of lamps	10.000 h
	dimension (L x B x H in mm)	1000 x 105 x 105
	number of lamps	1
	protection grade	IP 54
	electrical connection	110-240 50/60 Hz
	total power	48 W
	over current protection	10 A
<b>advantages</b>		
continuous operation, even if there are people staying in the room		
not affecting smell or taste		
low-maintenance operation		
low operational costs		

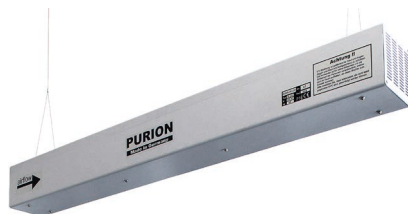

article number: 160 02100 0000

splinter protection  
wire suspension  
mounting rack

•



article number: 160 03800 0000

splinter protection  
wire suspension  
mounting rack

•

## equipment AIRPURION 48 active

PURION UV-lamp 48 W  
article number: 200 00500 0000



service-kit  
article number: 292 00900 0000





# AIRPURION 90 active



The AIRPURION 48 active consists of a matt anodized and completely closed aluminium frame. Wiring system and the electronic cut-in unit are integrated into the frame.

Scope of delivery of an AIRPURION active plant also contains a mounting rack or a wire suspension for assembly.

applications	product line	AIRPURION 48 active
production or packaging of food	turnover of ambient air	36 m <sup>3</sup> /h
medical technology	disinfection 80%	approx. 550 m <sup>3</sup>
	disinfection 88%	approx. 75 m <sup>3</sup>
laboratories	weight	6,0 kg
preparation rooms in hotel kitchen	life time of lamps	10.000 h
	dimension (L x B x H in mm)	1000 x 105 x 105
	number of lamps	1
	protection grade	IP 54
	electrical connection	110-240 50/60 Hz
	total power	90 W
	over current protection	10 A

advantages
continuous operation, even if there are people staying in the room
not affecting smell or taste
low-maintenance operation
low operational costs



article number: 160 02200 0000

splinter protection  
wire suspension  
mounting rack



article number: 160 03900 0000

splinter protection  
wire suspension  
mounting rack

## equipment AIRPURION 90 active

PURION UV-lamp 90 W  
article number: 200 00600 0000



service-kit  
article number: 292 00900 0000



# AIRPURION 300 active



The AIRPURION 300 active consists of a complete housing made from stainless steel. Wiring system and the electronic cut-in unit are integrated into the frame.

Scope of delivery of an AIRPURION active plant also contains a mounting rack or a wire suspension.

applications	product line	AIRPURION 300 active
production or packaging of food	turnover of ambient air	100 m <sup>2</sup> /h
medical technology	disinfection 80%	approx. 1.200 m <sup>3</sup>
	disinfection 88%	approx. 350 m <sup>3</sup>
laboratories	weight	14 kg
preparation rooms in hotel kitchen	life time of lamps	10.000 h
	dimension (L x B x H in mm)	1.100 x 200 x 200
	number of lamps	3
	protection grade	IP 54
	electrical connection	110-240 50/60 Hz
	total power	3x 90 W
	over current protection	10 A
<b>advantages</b>		
continuous operation, even if there are people staying in the room		
not affecting smell or taste		
low-maintenance operation		
low operational costs		



artikel-number: 160 03600 0000

splinter protection  
 wire suspension  
 mounting rack

•



artikel-number: 160 03700 0000

splinter protection  
 wire suspension  
 mounting rack

•

## equipment AIRPURION 300 active

PURION UV-lamp 90 W  
 article number: 200 00600 0000



service-kit  
 article number: 292 00900 0000



# AIRPURION DUO 90/39

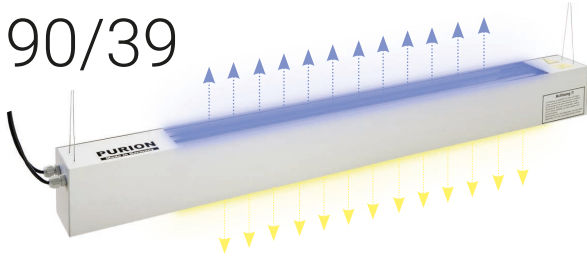

This equipment consists of a matt anodized aluminium profile with matching cover plates. The upward facing compartment holds the UV radiator for ambient disinfection. The downward facing compartment holds the D radiator for room lighting with especially natural light. Both radiators may be separately operated

For the equipment's ceiling suspension there is a stage less lowering cord-operated system available (wire suspension).

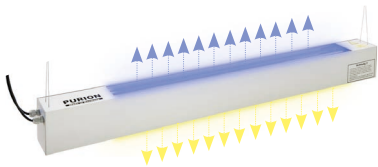

article number: 160 02700 0000  
article number: 160 03400 0000

alternating current	splinter protection	dry room	humid room
•	•		•
•			•

<b>applications</b>	<b>product line</b>	<b>AIRPURION DUO 90/39</b>
livestock farming	disinfections performance	100 m <sup>3</sup> (80% disinfection)
crop production	illumination	with natural light, vitamin D activator
medical applications	life time of lamps	10.000 h
<b>Advantages</b>	number of lamps	1 PURION UVC-Lampe 1 D Lampe
disinfection and vitalization	PURION UVC-lamp	90 W / 250-270 nm
better results in livestock farming	D lamp	39 W / 1 A colour-temperature 5.800 K
better work performance	electrical connection	240 V 50 Hz
low-maintenance operation	over current protection	10 A
low operational costs		
chemical free approach		

## 2 in 1 principle ...

The patented AIRPURION DUO plant is the only system with a real 2-functional approach to simultaneously remove bacteria's and ensure illumination with natural vitalizing light:

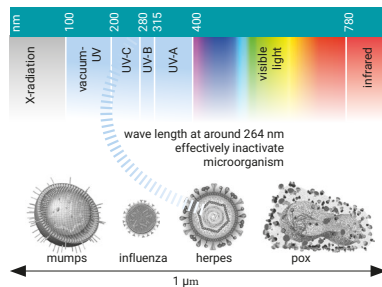

### 1<sup>st</sup> function: reliable UVC disinfection

Air is sterilized with UV-C light, as the only reliable technology for chemical free sterilization. High safety standard is guaranteed because UVC radiation is directed towards the ceiling.

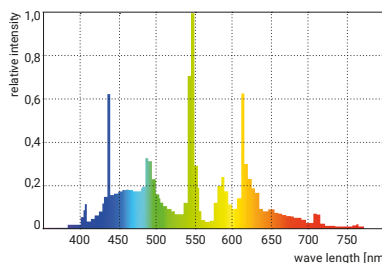

### 2<sup>nd</sup> function: illumination with vitalizing light

Light spectrum for room illumination is analogous to sunlight. Enhancement of vitamin D synthesis for strengthening the immune system and bone structure.

## did you know that ...

sunlight deficit can cause a weakening of the immune system and disorders of the nervous system?

sunlight deficit can lead to a reduction of human performance and within animal and crop production?

within intensive animal production most of the animals live their whole live with artificial illumination?

common air purification plants in the market

... use single technologies - either efficient to remove bacteria or to be used for illumination.

... most of the standard fluorescent light bulbs can not provide full replacement for natural sunlight.

... don't have safety features to prevent the release of glass splinters or mercury.

## value added at a glance ...

The patented two in one AIRPURION DUO plant is the only system that ensures simultaneously reliable UV disinfection and illumination with vitalizing light!

The AIRPURION DUO plants

... can compensate a deficit of natural sunlight.

... lead to optimal results within animal and crop production.

... can positively influence human labor power.

... work totally without chemicals.

... allow for continuous operation because UVC radiation is directed to the ceiling.

... can be equipped with various options to monitor the disinfection performance.

... imply easy maintenance and low operational costs.

## equipment AIRPURION DUO 90/39

PURION UV-lamp 90 W  
article number: 200 00600 0000



Bio Vital lamp 39 W  
article number: 200 01900 0000



service-kit  
article number: 292 00900 0000



# AIRPURION Sterile Fridge active



The AIR De-germinator AIRPURION Sterile fridge active enables systematic UV based disinfection and removal of bad odour within fridge rooms. The air is taken actively inside the plant via fan.

To meet highest safety standards the UV lamps can be equipped with special splinter protection (UV safety glass film). Within the standard scope of delivery of a plant AIRPURION Sterile Fridge an assembly system is included.

applications	product line	AIRPURION Sterile Fridge active
preparation of food	disinfection	approx. 50 m <sup>3</sup>
storage of food	dimension (LxBxH in mm)	340 x 405 x 105
pharmacy	weight	8,0 kg
laboratories	life time of lamps	10.000 h
	number of lamps	1x PURION UVC-lamp 1x UVA-lamp
	temperature min.	- 25°C
	protection grade	IP 54
	electrical connection	110-240 50/60 Hz
	total power	14W (PURION UVC-lamp) 6W (UVA-lamp)
	over current protection	10 A
	continuous operation, even if there are people staying in the room	
	disinfection and removal of bad odour	
	low-maintenance operation	
	low operational costs	



article number: 162 00100 0000  
article number: 162 00300 0000

alternating current  
splinter protection  
Operating Time Counter



article number: 162 00400 0000  
article number: 162 00200 0000

alternating current  
splinter protection  
Operating Time Counter

## 2 in 1 principle ...

The AIRPURION Sterile Fridge is the only system with a real two step approach to remove bacteria and bad odour.

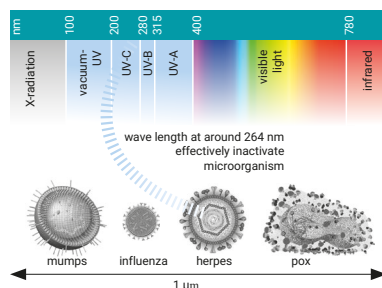

### 1<sup>st</sup> function: reliable UVC disinfection

Air is sterilized with UV-C light, as the only reliable technology for chemical free sterilization.

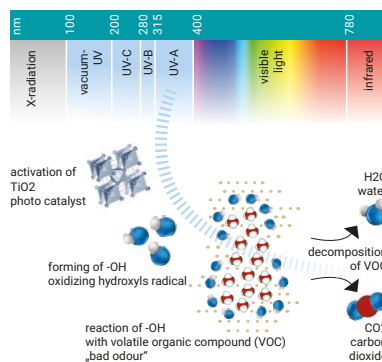

### 2<sup>nd</sup> step photo catalytic oxidation

Bad odour is removed via photo catalytic oxidation (PCO) via UV-A light and a titanium dioxide (TiO<sub>2</sub>) photo catalyst.

## did you know that ...

up to 30 % of food stored in walk in refrigerators is wasted due to unsanitary environment.

sterile environment means both: removal of bacteria and volatile organic compound (VOC) "bad odour".

common air purification plants in the market ... use single technologies - either efficient to remove bacteria or VOC. ... are neither ready to operate below -10 C° nor continuously. ... don't have safety features to prevent the release of glass splinters or mercury.

## value added at a glance ...

The superior two in one AIRPURION Sterile Fridge is the only system that ensures reliable UV disinfection and the removal of bad odour !

The AIRPURION Sterile Fridge ... considerably extends the shelf life of stored food. ... works totally without chemicals. ... is the only system with highest HACCP compliance due to splinter protection via UV glass safety film (no release of mercury or glass splinters in food areas in case of breakage of the UV lamp). ... allows for continuous operation because it is a closed system with active air inlet via fan. ... can be equipped with various options to monitor the disinfection performance. ... implies easy maintenance and low operational costs.

## equipment AIRPURION active MAX

service-kit  
article number: 292 00900 0000



PURION UV-lamp 14 W  
article number: 200 01500 0000



UVA-lamp 6 W  
article number: 200 02000 0000



# AIRPURION 2001/2



The AIRPURION 2001 /2 consist of two reactors PURION 2001 to be assembled in a row. The introduced air flows through the reactors and is disinfected by the UV radiation. The unit can be easily integrated into existing pipe systems. The controlling is integrated in an electronic control cabinet (optionally made from stainless steel).

<b>applications</b>	<b>product line</b>	<b>AIRPURION 2001/2</b>
disinfection of air within the beverage industry	disinfection 99%	approx. 60 m <sup>3</sup> /h
chemical industry with organic operational materials	dimensions (LxBxH in mm): reactors (in a row) electric control cabinet	578 x 186 x 85 600 x 600 x 210
clean room industry (ventilation concepts)	number of reactors	2x PURION 2001
	flanges	R 1 1/2"
	temperature max.	100 °C
	life time of lamps	8.000 or 10.000 h
	number of lamps	2
	protection grade	IP 65
	electrical connection	110-240 V 50/60 Hz
	total power	2x 48 W or 2x 42 ??

<b>details disinfection performance</b>		
max. volume of air		
guaranteed UVC-dosis	60% humidity	90% humidity
30 J/m <sup>2</sup>	60 m <sup>3</sup> /h	35 m <sup>3</sup> /h
90 J/m <sup>2</sup>	20 m <sup>3</sup> /h	12 m <sup>3</sup> /h

## CONFIGURATION ELECTRIC CONTROL CABINET: Steel powder-coated



article number: 166 00100 0000  
 article number: 166 00200 0000  
 article number: 166 00300 0000  
 article number: 166 00400 0000

- cold air up to 40°C
- hot air up to 100°C
- splinter protection
- Operating Time Counter



article number: 166 00500 0000  
 article number: 166 00600 0000  
 article number: 166 00700 0000  
 article number: 166 00800 0000

- cold air up to 40°C
- hot air up to 100°C
- splinter protection
- Operating Time Counter

## CONFIGURATION ELECTRIC CONTROL CABINET: stainless steel



article number: 166 00900 0000  
 article number: 166 01000 0000  
 article number: 166 01100 0000  
 article number: 166 01200 0000

- cold air up to 40°C
- hot air up to 100°C
- splinter protection
- Operating Time Counter



article number: 166 01300 0000  
 article number: 166 01400 0000  
 article number: 166 01500 0000  
 article number: 166 01600 0000

- cold air up to 40°C
- hot air up to 100°C
- splinter protection
- Operating Time Counter

## equipment AIRPURION-AIR Processing units 2001/2

PURION UV-lamp 48 W  
 article number: 200 00500 0000



PURION UV-lamp 42 W  
 article number: 200 01700 0000



PURION assembly system DUAL 2  
 article number: 290 11600 0000  
 article number: 290 11500 0000



service-kit  
 article number: 292 00900 0000

# AIRPURION 2001/4



The AIRPURION 2001 /4 consist of four reactors PURION 2001 to be assembled in a row. The introduced air flows through the reactors and is disinfected by the UV radiation. The unit can be easily integrated into existing pipe systems. The controlling is integrated in an electronic control cabinet (optionally made from stainless steel).

<b>applications</b>	<b>Product line</b>	<b>AIRPURION 2001/4</b>
disinfection of air within the beverage industry	disinfection 99%	approx. 120 m <sup>3</sup> /h
chemical industry with organic operational materials	dimensions (LxBxH in mm): reactors (in a row) electric control cabinet	578 x 372 x 85 600 x 600 x 210
clean room industry (ventilation concepts)	number of reactors	4x PURION 2001
	flanges	R 1 1/2"
	temperature max.	100 °C
	life time of lamps	8.000 or 10.000 h
	number of lamps	4
	protection grade	IP 65
	electrical connection	110-240 V 50/60 Hz
	total power	4x 48 W or 4x 42 ??

<b>details disinfection performance</b>		
max. volume of air		
guaranteed UVC-dosis	60% humidity	90% humidity
30 J/m <sup>2</sup>	120 m <sup>3</sup> /h	70 m <sup>3</sup> /h
90 J/m <sup>2</sup>	40 m <sup>3</sup> /h	24 m <sup>3</sup> /h

## CONFIGURATION ELECTRIC CONTROL CABINET: Steel powder-coated



article number: 166 01700 0000  
 article number: 166 01800 0000  
 article number: 166 01900 0000  
 article number: 166 02000 0000

cold air up to 40°C  
 hot air up to 100°C  
 splinter protection  
 Operating Time Counter

- 
- 
- 
- 



article number: 166 02100 0000  
 article number: 166 02200 0000  
 article number: 166 02300 0000  
 article number: 166 02400 0000

cold air up to 40°C  
 hot air up to 100°C  
 splinter protection  
 Operating Time Counter

- 
- 
- 
- 

## CONFIGURATION ELECTRIC CONTROL CABINET: stainless steel



article number: 166 02500 0000  
 article number: 166 02600 0000  
 article number: 166 02700 0000  
 article number: 166 02800 0000

cold air up to 40°C  
 hot air up to 100°C  
 splinter protection  
 Operating Time Counter

- 
- 
- 
- 



article number: 166 02900 0000  
 article number: 166 03000 0000  
 article number: 166 03100 0000  
 article number: 166 03200 0000

cold air up to 40°C  
 hot air up to 100°C  
 splinter protection  
 Operating Time Counter

- 
- 
- 
- 

## equipment AIRPURION-AIR Processing units 2001/4

service-kit  
 article number: 292 00900 0000



PURION UV-lamp 48 W  
 article number: 200 00500 0000



PURION UV-lamp 42 W  
 article number: 200 01700 0000



# AIRPURION 2501/2



applications	Product line	AIRPURION 2501/2
disinfection of air within the beverage industry	disinfection 99%	approx. 100 m <sup>3</sup> /h
chemical industry with organic operational materials	dimensions (LxBxH in mm): reactors (in a row) electric control cabinet	928 x 186 x 85 600 x 600 x 210
clean room industry (ventilation concepts)	number of reactors	2x PURION 2501
	flanges	R 1 1/2"
	temperature max.	100 °C
	life time of lamps	8.000 or 10.000 h
	number of lamps	2
	protection grade	IP 65
	electrical connection	110-240 V 50/60 Hz
	total power	2x 490 W or 2x 106 W

details disinfection performance		
max. volume of air		
guaranteed UVC-dosis	60% humidity	90% humidity
30 J/m <sup>2</sup>	60 m <sup>3</sup> /h	35 m <sup>3</sup> /h
90 J/m <sup>2</sup>	20 m <sup>3</sup> /h	12 m <sup>3</sup> /h

The AIRPURION 2501 /2 consist of two reactors PURION 2501 to be assembled in a row. The introduced air flows through the reactors and is disinfected by the UV radiation. The unit can be easily integrated into existing pipe systems. The controlling is integrated in an electronic control cabinet (optionally made from stainless steel).

## CONFIGURATION ELECTRIC CONTROL CABINET: Steel powder-coated



article number: 166 03300 0000  
 article number: 166 03400 0000  
 article number: 166 03500 0000  
 article number: 166 03600 0000

•	•	•	•
•	•	•	•



article number: 166 03700 0000  
 article number: 166 03800 0000  
 article number: 166 03900 0000  
 article number: 166 04000 0000

•	•	•	•
•	•	•	•

## CONFIGURATION ELECTRIC CONTROL CABINET: stainless steel



article number: 166 04100 0000  
 article number: 166 04200 0000  
 article number: 166 04300 0000  
 article number: 166 04400 0000

•	•	•	•
•	•	•	•



article number: 166 04500 0000  
 article number: 166 04600 0000  
 article number: 166 04700 0000  
 article number: 166 04800 0000

•	•	•	•
•	•	•	•

## equipment AIRPURION-AIR Processing units 2501/2

PURION UV-lamp 90 W  
 article number: 200 00600 0000



PURION UV-lamp 106 W  
 article number: 200 00800 0000



PURION assembly system DUAL 2  
 article number: 290 11600 0000  
 article number: 290 11500 0000



service-kit  
 article number: 292 00900 0000

# AIRPURION 2501/4



The AIRPURION 2501 /4 consist of four reactors PURION 2501 to be assembled in a row. The introduced air flows through the reactors and is disinfected by the UV radiation. The unit can be easily integrated into existing pipe systems. The controlling is integrated in an electronic control cabinet (optionally made from stainless steel).

applications	Product line	AIRPURION 2501/4
disinfection of air within the beverage industry	disinfection 99%	approx. 200 m <sup>3</sup> /h
chemical industry with organic operational materials	dimensions (LxBxH in mm): reactors (in a row) electric control cabinet	928 x 372 x 85 600 x 600 x 210
clean room industry (ventilation concepts)	number of reactors	4x PURION 2501
	flanges	R 1 1/2"
	temperature max.	100 °C
	life time of lamps	8.000 or 10.000 h
	number of lamps	4
	protection grade	IP 65
	electrical connection	110-240 V 50/60 Hz
	total power	4x 90 W or 4x 106 W

details disinfection performance		
max. volume of air		
guaranteed UVC-dosis	60% humidity	90% humidity
30 J/m <sup>2</sup>	200 m <sup>3</sup> /h	120 m <sup>3</sup> /h
90 J/m <sup>2</sup>	70 m <sup>3</sup> /h	40 m <sup>3</sup> /h

## CONFIGURATION ELECTRIC CONTROL CABINET: Steel powder-coated

<ul style="list-style-type: none"> <li>• cold air up to 40°C</li> <li>• hot air up to 100°C</li> <li>• splinter protection</li> <li>• Operating Time Counter</li> </ul>	<ul style="list-style-type: none"> <li>• article number: 166 04900 0000</li> <li>• article number: 166 05000 0000</li> <li>• article number: 166 05100 0000</li> <li>• article number: 166 05200 0000</li> </ul>
---	--

<ul style="list-style-type: none"> <li>• cold air up to 40°C</li> <li>• hot air up to 100°C</li> <li>• splinter protection</li> <li>• Operating Time Counter</li> </ul>	<ul style="list-style-type: none"> <li>• article number: 166 05300 0000</li> <li>• article number: 166 05400 0000</li> <li>• article number: 166 05500 0000</li> <li>• article number: 166 05600 0000</li> </ul>
---	--

## CONFIGURATION ELECTRIC CONTROL CABINET: stainless steel

<ul style="list-style-type: none"> <li>• cold air up to 40°C</li> <li>• hot air up to 100°C</li> <li>• splinter protection</li> <li>• Operating Time Counter</li> </ul>	<ul style="list-style-type: none"> <li>• article number: 166 05700 0000</li> <li>• article number: 166 05800 0000</li> <li>• article number: 166 05900 0000</li> <li>• article number: 166 06000 0000</li> </ul>
---	--

<ul style="list-style-type: none"> <li>• cold air up to 40°C</li> <li>• hot air up to 100°C</li> <li>• splinter protection</li> <li>• Operating Time Counter</li> </ul>	<ul style="list-style-type: none"> <li>• article number: 166 06100 0000</li> <li>• article number: 166 06200 0000</li> <li>• article number: 166 06300 0000</li> <li>• article number: 166 06400 0000</li> </ul>
---	--

## equipment AIRPURION-AIR Processing units 2501/4

service-kit  
article number: 292 00900 0000



PURION UV-lamp 90 W  
article number: 200 00600 0000



PURION UV-lamp 106 W  
article number: 200 00800 0000





# AIRPURION 2501/6



The AIRPURION 2501 /6 consist of six reactors PURION 2501 to be assembled in a row. The introduced air flows through the reactors and is disinfected by the UV radiation. The unit can be easily integrated into existing pipe systems. The controlling is integrated in an electronic control cabinet (optionally made from stainless steel).

applications	Product line	AIRPURION 2501/6
disinfection of air within the beverage industry	disinfection 99%	approx. 300 m <sup>3</sup> /h
chemical industry with organic operational materials	dimensions (LxBxH in mm): reactors (in a row) electric control cabinet	928 x 558 x 85 600 x 600 x 210
clean room industry (ventilation concepts)	number of reactors	6x PURION 2501
	flanges	R 1 1/2"
	temperature max.	100 °C
	life time of lamps	8.000 or 10.000 h
	number of lamps	6
	protection grade	IP 65
	electrical connection	110-240 V 50/60 Hz
	total power	6x 490 W or 6x 106 W

details disinfection performance		
max. volume of air		
guaranteed UVC-dosis	60% humidity	90% humidity
30 J/m <sup>2</sup>	300 m <sup>3</sup> /h	180 m <sup>3</sup> /h
90 J/m <sup>2</sup>	100 m <sup>3</sup> /h	60 m <sup>3</sup> /h

## CONFIGURATION ELECTRIC CONTROL CABINET: Steel powder-coated

Reactor Unit	Control Cabinet	Temperature Range	Protection	Operating Time Counter
		cold air up to 40°C	splinter protection	Operating Time Counter
article number: 166 06500 0000		•	•	•
article number: 166 06600 0000		•	•	•
article number: 166 06700 0000		•	•	•
article number: 166 06800 0000		•	•	•
		cold air up to 40°C	splinter protection	Operating Time Counter
article number: 166 06900 0000		•	•	•
article number: 166 07000 0000		•	•	•
article number: 166 07100 0000		•	•	•
article number: 166 07200 0000		•	•	•

## CONFIGURATION ELECTRIC CONTROL CABINET: stainless steel

Reactor Unit	Control Cabinet	Temperature Range	Protection	Operating Time Counter
		cold air up to 40°C	splinter protection	Operating Time Counter
article number: 166 07300 0000		•	•	•
article number: 166 07400 0000		•	•	•
article number: 166 07500 0000		•	•	•
article number: 166 07600 0000		•	•	•
		cold air up to 40°C	splinter protection	Operating Time Counter
article number: 166 07700 0000		•	•	•
article number: 166 07800 0000		•	•	•
article number: 166 07900 0000		•	•	•
article number: 166 08000 0000		•	•	•

## equipment AIRPURION-AIR Processing units 2501/6

PURION UV-lamp 90 W  
article number: 200 00600 0000



PURION UV-lamp 106 W  
article number: 200 00800 0000



service-kit  
article number: 292 00900 0000



# AIRPURION 2501/8



The AIRPURION 2501 /8 consist of eight reactors PURION 2501 to be assembled in a row. The introduced air flows through the reactors and is disinfected by the UV radiation. The unit can be easily integrated into existing pipe systems. The controlling is integrated in an electronic control cabinet (optionally made from stainless steel).

applications	Product line	AIRPURION 2501/8
disinfection of air within the beverage industry	disinfection 99%	approx. 400 m <sup>3</sup> /h
chemical industry with organic operational materials	dimensions (LxBxH in mm): reactors (in a row) electric control cabinet	928 x 744 x 85 600 x 600 x 210
clean room industry (ventilation concepts)	number of reactors	8x PURION 2501
	flanges	R 1 1/2"
	temperature max.	100 °C
	life time of lamps	8.000 or 10.000 h
	number of lamps	8
	protection grade	IP 65
	electrical connection	110-240 V 50/60 Hz
	total power	8x 90 W or 8x 106 W

details disinfection performance		
max. volume of air		
guaranteed UVC-dosis	60% humidity	90% humidity
30 J/m <sup>2</sup>	400 m <sup>3</sup> /h	230 m <sup>3</sup> /h
90 J/m <sup>2</sup>	135 m <sup>3</sup> /h	80 m <sup>3</sup> /h

## CONFIGURATION ELECTRIC CONTROL CABINET: Steel powder-coated

article number:	cold air up to 40°C	hot air up to 100°C	splinter protection	Operating Time Counter
166 08100 0000	•			
166 08200 0000		•		
166 08300 0000	•		•	
166 08400 0000		•		•

article number:	cold air up to 40°C	hot air up to 100°C	splinter protection	Operating Time Counter
166 08500 0000	•			•
166 08600 0000		•		•
166 08700 0000	•		•	•
166 08800 0000		•	•	•

## CONFIGURATION ELECTRIC CONTROL CABINET: stainless steel

article number:	cold air up to 40°C	hot air up to 100°C	splinter protection	Operating Time Counter
166 08900 0000	•			
166 09000 0000		•		
166 09100 0000	•		•	
166 09200 0000		•	•	•

article number:	cold air up to 40°C	hot air up to 100°C	splinter protection	Operating Time Counter
166 09300 0000	•			•
166 09400 0000		•		•
166 09500 0000	•		•	•
166 09600 0000		•	•	•

## equipment AIRPURION-AIR Processing units 2501/8

service-kit  
article number: 292 00900 0000



PURION UV-lamp 90 W  
article number: 200 00600 0000



PURION UV-lamp 106 W  
article number: 200 00800 0000



# UV-Set PURION 10 W



The UV set consists of a quartz-made protective tube which is closed at one end while the other one is placed into a stainless steel flange, a PURION UV-lamp, the distribution box with its electronic cut-in unit and the connecting cables. The flange made from stainless steel has three boreholes by which it can be tightly screwed down (like for instance to the housing's walls).

applications	product line	PURION UV-Set 10 W
disinfection of air and climate channel	flow rate and disinfection power	depending on medium and geometrical structure
tank disinfection	radiation length	145 mm
conveyor band disinfection	dimensions: seal flanges up to the end of the quartz tube	312 mm
surface disinfection	Ø quartz tube	23 mm
	Ø diameter flange	60 mm
	Ø hole circle flange seal	Ø 48, 3x 120°, Ø 5,5
	weight	1 kg
	life time of lamps	10.000 h
	temperature max.	40°C
	number of lamps	1
	protection grade	IP 65
	electrical connection	230 V/50 Hz or 110-240 V 50/60 Hz 12 V DC or 24 V DC
	total power	10 W
	over current protection	10 A

### advantages

- no chemicals added to the medium being disinfected
- not affecting odour or taste
- low-maintenance operation
- low operational costs

## alternating current (VAC)

article-no.: 150 01600 0000  
 article-no.: 150 04900 0000

alternating current AC	wide voltage	splinter protection	Operating Time Counter	potential free contacts
•	•	•	•	•

article-no.: 150 11100 0000  
 article-no.: 150 11200 0000

alternating current AC	wide voltage	splinter protection	Operating Time Counter	potential free contacts
•	•	•	•	•

article-no.: 150 02700 0000  
 article-no.: 150 11000 0000

alternating current AC	wide voltage	splinter protection	Operating Time Counter	potential free contacts
•	•	•	•	•

article-no.: 150 11300 0000  
 article-no.: 150 11400 0000

alternating current AC	wide voltage	splinter protection	Operating Time Counter	potential free contacts
•	•	•	•	•

## direct current (VAC)

article-no.: 150 01500 0000  
 article-no.: 150 03000 0000

direct current 12 V DC	direct current 24 V DC	splinter protection	Operating Time Counter	potential free contacts
•	•	•	•	•

article-no.: 150 11500 0000  
 article-no.: 150 11600 0000

direct current 12 V DC	direct current 24 V DC	splinter protection	Lebensdauerüberwachung	potential free Kontakte
•	•	•	•	•

article-no.: 150 02800 0000  
 article-no.: 150 02900 0000  
 article-no.: 150 11700 0000  
 article-no.: 150 11800 0000

direct current 12 V DC	direct current 24 V DC	splinter protection	Operating Time Counter	potential free contacts
•	•	•	•	•

article-no.: 150 11900 0000  
 article-no.: 150 12000 0000  
 article-no.: 150 12100 0000  
 article-no.: 150 12200 0000

direct current 12 V DC	direct current 24 V DC	splinter protection	Operating Time Counter	potential free contacts
•	•	•	•	•

## equipment PURION UV-Set 10 W

PURION UV-lamp 10 W  
 article number: 200 01300 0000



service-kit  
 article number: 292 00900 0000



PURION assembly system switch box  
 article number: 290 12100 0000



# UV-Set PURION 10 W short



The UV set consists of a quartz-made protective tube which is closed at one end while the other one is placed into a stainless steel flange, a PURION UV-lamp, the distribution box with its electronic cut-in unit and the connecting cables.

The flange made from stainless steel has three boreholes by which it can be tightly screwed down (like for instance to the housing's walls).

applications	product line	PURION UV-Set 10 W short
disinfection of air and climate channel	flow rate and disinfection power	depending on medium and geometrical structure
tank disinfection	radiation length	145 mm
conveyor band disinfection	dimensions:	
surface disinfection	seal flanges up to the end of the quartz tube	229 mm
	Ø quartz tube	23 mm
	Ø diameter flange	60 mm
	Ø hole circle flange seal	Ø 48, 3x 120°, Ø 5,5
		VITON / FPM
advantages	weight	1 kg
	life time of lamps	10.000 h
no chemicals added to the medium being disinfected	temperature max.	40°C
not affecting odour or taste	number of lamps	1
low-maintenance operation	protection grade	IP 65
	electrical connection	230 V/50 Hz or 110-240 V 50/60 Hz 12 V DC or 24 V DC
low operational costs	total power	10 W
	over current protection	10 A

## alternating current (VAC)

article-no.: 150 06500 0000  
 article-no.: 150 12300 0000

alternating current AC	wide voltage	splinter protection	Operating Time Counter	potential free contacts
•	•			

article-no.: 150 05500 0000  
 article-no.: 150 12400 0000

alternating current AC	wide voltage	splinter protection	Operating Time Counter	potential free contacts
•	•			

article-no.: 150 12500 0000  
 article-no.: 150 12600 0000

alternating current AC	wide voltage	splinter protection	Operating Time Counter	potential free contacts
•	•		•	•

article-no.: 150 12700 0000  
 article-no.: 150 12800 0000

alternating current AC	wide voltage	splinter protection	Operating Time Counter	potential free contacts
•	•		•	•

## direct current (VAC)

article-no.: 150 09900 0000  
 article-no.: 150 10700 0000

direct current 12 V DC	direct current 24 V DC	splinter protection	Operating Time Counter	potential free contacts
•	•			

article-no.: 150 07000 0000  
 article-no.: 150 12900 0000

direct current 12 V DC	direct current 24 V DC	splinter protection	Operating Time Counter	potential free contacts
•	•			

article-no.: 150 10900 0000  
 article-no.: 150 13000 0000  
 article-no.: 150 13100 0000  
 article-no.: 150 13200 0000

direct current 12 V DC	direct current 24 V DC	splinter protection	Operating Time Counter	potential free contacts
•	•		•	•

article-no.: 150 13300 0000  
 article-no.: 150 13400 0000  
 article-no.: 150 13500 0000  
 article-no.: 150 13600 0000

direct current 12 V DC	direct current 24 V DC	splinter protection	Operating Time Counter	potential free contacts
•	•		•	•

## equipment PURION UV-Set 10 W short

PURION UV-lamp 10 W  
 article number: 200 01300 0000



PURION assembly system switch box  
 article number: 290 12100 0000



service-kit  
 article number: 292 00900 0000



# UV-Set PURION 14 W



The UV set consists of a quartz-made protective tube which is closed at one end while the other one is placed into a stainless steel flange, a PURION UV-lamp, the distribution box with its electronic cut-in unit and the connecting cables. The flange made from stainless steel has three boreholes by which it can be tightly screwed down (like for instance to the housing's walls).

applications	product line	PURION UV-Set 14 W
disinfection of air and climate channel	flow rate and disinfection power	depending on medium and geometrical structure
tank disinfection	radiation length	220 mm
conveyor band disinfection	dimensions: seal flanges up to the end of the quartz tube	312 mm
surface disinfection	Ø quartz tube	23 mm
	Ø diameter flange	60 mm
	Ø hole circle flange seal	Ø 48, 3x 120°, Ø 5,5
	weight	1 kg
advantages	life time of lamps	10.000 h
	temperature max.	40°C
not affecting odour or taste	number of lamps	1
low-maintenance operation	protection grade	IP 65
	electrical connection	230 V/50 Hz or 110-240 V 50/60 Hz 12 V DC or 24 V DC
low operational costs	total power	14 W
	over current protection	10 A

## alternating current (VAC)



article-no.: 150 04800 0000

- alternating current AC
- wide voltage
- splinter protection
- Operating Time Counter
- potential free contacts



article-no.: 150 04700 0000

- alternating current AC
- wide voltage
- splinter protection
- Operating Time Counter
- potential free contacts



article-no.: 150 06800 0000

- alternating current AC
- wide voltage
- splinter protection
- Operating Time Counter
- potential free contacts



article-no.: 150 13900 0000

- alternating current AC
- wide voltage
- splinter protection
- Operating Time Counter
- potential free contacts

## direct current (VAC)



article-no.: 150 14100 0000

- direct current 12 V DC
- direct current 24 V DC
- splinter protection
- Operating Time Counter
- potential free contacts



article-no.: 150 05900 0000

- direct current 12 V DC
- direct current 24 V DC
- splinter protection
- Operating Time Counter
- potential free contacts



article-no.: 150 14300 0000

- direct current 12 V DC
- direct current 24 V DC
- splinter protection
- Operating Time Counter
- potential free contacts



article-no.: 150 14700 0000

- direct current 12 V DC
- direct current 24 V DC
- splinter protection
- Operating Time Counter
- potential free contacts

## equipment PURION UV-Set 14 W

PURION UV-lamp 14 W  
article number: 200 01500 0000



service-kit  
article number: 292 00900 0000



PURION assembly system switch box  
article number: 290 12100 0000



# UV-Set PURION 17 W



The UV set consists of a quartz-made protective tube which is closed at one end while the other one is placed into a stainless steel flange, a PURION UV-lamp, the distribution box with its electronic cut-in unit and the connecting cables. The flange made from stainless steel has three boreholes by which it can be tightly screwed down (like for instance to the housing's walls).

applications	product line	PURION UV-Set 17 W
disinfection of air and climate channel	flow rate and disinfection power	depending on medium and geometrical structure
tank disinfection	radiation length	280 mm
conveyor band disinfection	dimensions:	seal flanges up to the end of the quartz tube 412 mm
surface disinfection	Ø quartz tube	23 mm
	Ø diameter flange	60 mm
	Ø hole circle flange	Ø 48, 3x 120°, Ø 5,5 seal
	seal	VITON / FPM
	weight	1 kg
	life time of lamps	10.000 h
	temperature max.	40°C
	number of lamps	1
	protection grade	IP 65
	electrical connection	230 V/50 Hz or 110-240 V 50/60 Hz 12 V DC or 24 V DC
	total power	17 W
	over current protection	10 A

## advantages

no chemicals added to the medium being disinfected

not affecting odour or taste

low-maintenance operation

low operational costs

## alternating current (VAC)

article-no.: 150 00900 0000  
 article-no.: 150 10600 0000

alternating current AC	wide voltage	splinter protection	Operating Time Counter	potential free contacts
•	•	•	•	•

article-no.: 150 15100 0000  
 article-no.: 150 15200 0000

alternating current AC	wide voltage	splinter protection	Operating Time Counter	potential free contacts
•	•	•	•	•

article-no.: 150 03100 0000  
 article-no.: 150 15300 0000

alternating current AC	wide voltage	splinter protection	Operating Time Counter	potential free contacts
•	•	•	•	•

article-no.: 150 15400 0000  
 article-no.: 150 15500 0000

alternating current AC	wide voltage	splinter protection	Operating Time Counter	potential free contacts
•	•	•	•	•

## direct current (VAC)

article-no.: 150 02200 0000  
 article-no.: 150 01300 0000

direct current 12 V DC	direct current 24 V DC	splinter protection	Operating Time Counter	potential free contacts
•	•	•	•	•

article-no.: 150 15600 0000  
 article-no.: 150 15700 0000

direct current 12 V DC	direct current 24 V DC	splinter protection	Operating Time Counter	potential free contacts
•	•	•	•	•

article-no.: 150 03200 0000  
 article-no.: 150 03300 0000  
 article-no.: 150 15800 0000  
 article-no.: 150 15900 0000

direct current 12 V DC	direct current 24 V DC	splinter protection	Operating Time Counter	potential free contacts
•	•	•	•	•

article-no.: 150 16000 0000  
 article-no.: 150 16100 0000  
 article-no.: 150 16200 0000  
 article-no.: 150 16300 0000

direct current 12 V DC	direct current 24 V DC	splinter protection	Operating Time Counter	potential free contacts
•	•	•	•	•

## equipment PURION UV-Set 17 W

PURION UV-lamp 17 W  
 article number: 200 00300 0000



PURION assembly system switch box  
 article number: 290 12100 0000



service-kit  
 article number: 292 00900 0000



# UV-Set PURION 36 W

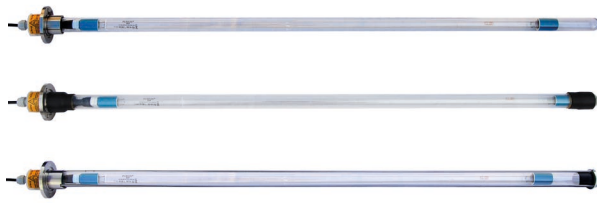

The UV set consists of a quartz-made protective tube which is closed at one end while the other one is placed into a stainless steel flange, a PURION UV-lamp, the distribution box with its electronic cut-in unit and the connecting cables.

The flange made from stainless steel has three boreholes by which it can be tightly screwed down (like for instance to the housing's walls).

applications	product line	PURION UV-Set 36 W
disinfection of air and climate channel	flow rate and disinfection power	depending on medium and geometrical structure
tank disinfection	radiation length	720 mm
conveyor band disinfection	dimensions: seal flanges up to the end of the quartz tube	920 mm
surface disinfection	Ø quartz tube	23 mm
	Ø diameter flange	60 mm
advantages	Ø hole circle flange seal	Ø 48, 3x 120°, Ø 5,5 VITON / FPM
	weight	2,5 kg
no chemicals added to the medium being disinfected	life time of lamps	10.000 h
	temperature max.	40°C
not affecting odour or taste	number of lamps	1
low-maintenance operation	protection grade	IP 65
	electrical connection	110-240 V 50/60 Hz or 24 V DC
low operational costs	total power	36 W
	over current protection	10 A

## alternating current (VAC)



article-number: 150 02400 0000	alternating current AC	wide voltage	splinter protection	safety basket	Operating Time Counter	potential free contacts
article-number: 150 19500 0000	•	•	•	•	•	•



article-number: 150 05700 0000	alternating current AC	wide voltage	splinter protection	safety basket	Operating Time Counter	potential free contacts
	•	•	•	•	•	•



article-number: 150 03400 0000	alternating current AC	wide voltage	splinter protection	safety basket	Operating Time Counter	potential free contacts
article-number: 150 16400 0000	•	•	•	•	•	•
article-number: 150 19600 0000	•	•	•	•	•	•
article-number: 150 19700 0000	•	•	•	•	•	•



article-number: 150 16500 0000	alternating current AC	wide voltage	splinter protection	safety basket	Operating Time Counter	potential free contacts
article-number: 150 16600 0000	•	•	•	•	•	•

## direct current (VAC)



article-number: 150 05600 0000	direct current 12 V DC	direct current 24 V DC	splinter protection	safety basket	Operating Time Counter	potential free contacts
article-number: 150 19800 0000	•	•	•	•	•	•



article-number: 150 16700 0000	direct current 12 V DC	direct current 24 V DC	splinter protection	safety basket	Operating Time Counter	potential free contacts
	•	•	•	•	•	•



article-number: 150 16800 0000	direct current 12 V DC	direct current 24 V DC	splinter protection	safety basket	Operating Time Counter	potential free contacts
article-number: 150 16900 0000	•	•	•	•	•	•
article-number: 150 19900 0000	•	•	•	•	•	•
article-number: 150 20000 0000	•	•	•	•	•	•



article-number: 150 17000 0000	direct current 12 V DC	direct current 24 V DC	splinter protection	safety basket	Operating Time Counter	potential free contacts
article-number: 150 17100 0000	•	•	•	•	•	•

## equipment PURION UV-Set 36 W

PURION UV lamp 36 W  
article-number: 200 00400 0000



PURION assembly system switch box  
article-number: 290 12100 0000















# UV-Set PURION 42 W short



The UV set consists of a quartz-made protective tube which is closed at one end while the other one is placed into a stainless steel flange, a PURION UV-lamp, the distribution box with its electronic cut-in unit and the connecting cables. The flange made from stainless steel has three boreholes by which it can be tightly screwed down (like for instance to the housing's walls).

applications	product line	PURION UV-Set 42 W short
disinfection of air and climate channel	flow rate and disinfection power	depending on medium and geometrical structure
tank disinfection	radiation length	280 mm
conveyor band disinfection	dimensions:	
surface disinfection	seal flanges up to the end of the quartz tube	412 mm
	Ø quartz tube	23 mm
	Ø diameter flange	60 mm
	Ø hole circle flange seal	Ø 48, 3x 120°, Ø 5,5 VITON / FPM
advantages	weight	2 kg
	life time of lamps	8.000 h
no chemicals added to the medium being disinfected	temperature max.	60°C - 100 °C
not affecting odour or taste	number of lamps	1
low-maintenance operation	protection grade	IP 65
	electrical connection	110-240 V 50/60 Hz
low operational costs	total power	42 W
	over current protection	10 A

## alternating current (VAC)

		alternating current AC	•	wide voltage	•	splinter protection	•	Operating Time Counter	•	potential free contacts	•
article-number: 150 03900 0000											
		alternating current AC	•	wide voltage	•	splinter protection	•	Operating Time Counter	•	potential free contacts	•
article-number: 150 07300 0000											
		alternating current AC	•	wide voltage	•	splinter protection	•	Operating Time Counter	•	potential free contacts	•
article-number: 150 10400 0000											
		alternating current AC	•	wide voltage	•	splinter protection	•	Operating Time Counter	•	potential free contacts	•
article-number: 150 17200 0000											
		alternating current AC	•	wide voltage	•	splinter protection	•	Operating Time Counter	•	potential free contacts	•
article-number: 150 17300 0000											
		alternating current AC	•	wide voltage	•	splinter protection	•	Operating Time Counter	•	potential free contacts	•
article-number: 150 17400 0000											

## equipment PURION UV-Set 42 W short

PURION assembly system switch box  
article number: 290 12100 0000



PURION UV-lamp 42 W  
article number: 200 01700 0000



service-kit  
article number: 292 00900 0000





# UV-Set PURION 48 W



The UV set consists of a quartz-made protective tube which is closed at one end while the other one is placed into a stainless steel flange, a PURION UV-lamp, the distribution box with its electronic cut-in unit and the connecting cables. The flange made from stainless steel has three boreholes by which it can be tightly screwed down (like for instance to the housing's walls).

applications	product line	PURION UV-Set 48 W
disinfection of air and climate channel	flow rate and disinfection power	depending on medium and geometrical structure
tank disinfection	radiation length	320 mm
conveyor band disinfection	dimensions:	
surface disinfection	seal flanges up to the end of the quartz tube	570 mm
	Ø quartz tube	23 mm
	Ø diameter flange	60 mm
	Ø hole circle flange seal	Ø 48, 3x 120°, Ø 5,5
		VITON / FPM
advantages	weight	2 kg
	life time of lamps	10.000 h
no chemicals added to the medium being disinfected	temperature max.	40°C
not affecting odour or taste	number of lamps	1
low-maintenance operation	protection grade	IP 65
	electrical connection	110-240 V 50/60 Hz
low operational costs	total power	48 W
	over current protection	10 A

## alternating current (VAC)



article-no.: 150 01100 0000



alternating current AC  
• wide voltage  
• splinter protection  
• Operating Time Counter  
• potential free contacts



article-no.: 150 05300 0000



alternating current AC  
• wide voltage  
• splinter protection  
• Operating Time Counter  
• potential free contacts



article-no.: 150 02500 0000

article-no.: 150 17500 0000



alternating current AC  
• wide voltage  
• splinter protection  
• Operating Time Counter  
• potential free contacts



article-no.: 150 17600 0000

article-no.: 150 17700 0000



alternating current AC  
• wide voltage  
• splinter protection  
• Operating Time Counter  
• potential free contacts

## equipment PURION UV-Set 48 W

PURION UV-lamp 48 W  
article number: 200 00500 0000



service-kit  
article number: 292 00900 0000



PURION assembly system switch box  
article number: 290 12100 0000



# UV-Set PURION 90 W

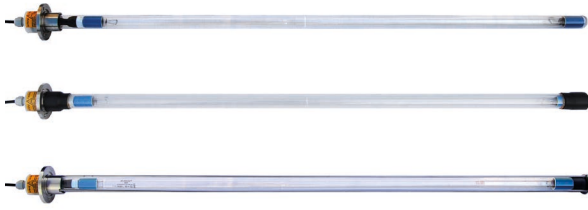

The UV set consists of a quartz-made protective tube which is closed at one end while the other one is placed into a stainless steel flange, a PURION UV-lamp, the distribution box with its electronic cut-in unit and the connecting cables.

The flange made from stainless steel has three boreholes by which it can be tightly screwed down (like for instance to the housing's walls).

applications	product line	PURION UV-Set 90 W
disinfection of air and climate channel	flow rate and disinfection power	depending on medium and geometrical structure
tank disinfection	radiation length	730 mm
conveyor band disinfection	dimensions:	seal flanges up to the end of the quartz tube 920 mm
surface disinfection	Ø quartz tube	23 mm
	Ø diameter flange	60 mm
	Ø hole circle flange	Ø 48, 3x 120°, Ø 5,5
	seal	VITON / FPM
advantages	weight	2,5 kg
	life time of lamps	10.000 h
	temperature max.	40°C
	number of lamps	1
not affecting odour or taste	protection grade	IP 65
low-maintenance operation	electrical connection	110-240 V 50/60 Hz
	total power	90 W
low operational costs	over current protection	10 A

## alternating current (VAC)

article-number: 150 03500 0000  
 article-number: 150 20100 0000

alternating current AC	wide voltage	splinter protection	safety basket	Operating Time Counter	potential free contacts
•	•	•	•	•	•

article-number: 150 05100 0000

alternating current AC	wide voltage	splinter protection	safety basket	Operating Time Counter	potential free contacts
•	•	•	•	•	•

article-number: 150 02600 0000  
 article-number: 150 17800 0000  
 article-number: 150 20200 0000  
 article-number: 150 20300 0000

alternating current AC	wide voltage	splinter protection	safety basket	Operating Time Counter	potential free contacts
•	•	•	•	•	•

article-number: 150 06600 0000  
 article-number: 150 17900 0000

alternating current AC	wide voltage	splinter protection	safety basket	Operating Time Counter	potential free contacts
•	•	•	•	•	•

## equipment PURION UV-Set 90 W

PURION assembly system switch box  
 article number: 290 12100 0000



PURION UV-lamp 90 W  
 article number: 200 00600 0000



service-kit  
 article number: 292 00900 0000



# UV-Set PURION 10 W DUAL



The UV set consists of two quartz-made protective tubes which are closed at one end while the other one is placed into a stainless steel flange, two PURION UV-lamps, the distribution box with its electronic cut-in unit and the connecting cables.

The flanges made from stainless steel have three boreholes by which they can be tightly screwed down (like for instance to the housing's walls).

applications	product line	PURION UV-Set 10 W DUAL
disinfection of air and climate channel	flow rate and disinfection power	depending on medium and geometrical structure
tank disinfection	radiation length	2x 145 mm
conveyor band disinfection	dimensions: seal flanges up to the end of the quartz tube	312 mm
surface disinfection	Ø quartz tube	23 mm
	Ø diameter flange	60 mm
	Ø hole circle flange seal	Ø 48, 3x 120°, Ø 5,5
	seal	VITON / FPM
advantages	weight	1,8 kg
	life time of lamps	10.000 h
	temperature max.	40°C
	number of lamps	2
not affecting odour or taste	protection grade	IP 65
low-maintenance operation	electrical connection	110-240 V 50/60 Hz
	total power	2x 10 W
low operational costs	over current protection	10 A

## alternating current (VAC)

article-no.: 150 03800 0000

- alternating current AC
- wide voltage
- splinter protection
- Operating Time Counter
- potential free contacts

article-no.: 150 07900 0000

- alternating current AC
- wide voltage
- splinter protection
- Operating Time Counter
- potential free contacts

article-no.: 150 07800 0000  
article-no.: 150 18000 0000

- alternating current AC
- wide voltage
- splinter protection
- Operating Time Counter
- potential free contacts

article-no.: 150 08000 0000  
article-no.: 150 18100 0000

- alternating current AC
- wide voltage
- splinter protection
- Operating Time Counter
- potential free contacts

## equipment PURION UV-Set 10 W DUAL

PURION UV-lamp 10 W  
article number: 200 01300 0000



service-kit  
article number: 292 00900 0000



PURION assembly system switch box  
article number: 290 12100 0000



# UV-Set PURION 10 W short DUAL



The UV set consists of two quartz-made protective tubes which are closed at one end while the other one is placed into a stainless steel flange, two PURION UV-lamps, the distribution box with its electronic cut-in unit and the connecting cables.

The flanges made from stainless steel have three boreholes by which they can be tightly screwed down (like for instance to the housing's walls).

applications	product line	PURION UV-Set 10 W short DUAL
disinfection of air and climate channel	flow rate and disinfection power	depending on medium and geometrical structure
tank disinfection	radiation length	2x 145 mm
conveyor band disinfection	dimensions:	
surface disinfection	seal flanges up to the end of the quartz tube	229 mm
	Ø quartz tube	23 mm
	Ø diameter flange	60 mm
	Ø hole circle flange seal	Ø 48, 3x 120°, Ø 5,5 VITON / FPM
advantages	weight	1,8 kg
	life time of lamps	10.000 h
no chemicals added to the medium being disinfected	temperature max.	40°C
not affecting odour or taste	number of lamps	2
low-maintenance operation	protection grade	IP 65
	electrical connection	110-240 V 50/60 Hz
low operational costs	total power	2x 10 W
	over current protection	10 A

## alternating current (VAC)

article-no.: 150 08300 0000

- alternating current AC
- wide voltage
- splinter protection
- Operating Time Counter
- potential free contacts

article-no.: 150 08600 0000

- alternating current AC
- wide voltage
- splinter protection
- Operating Time Counter
- potential free contacts

article-no.: 150 08400 0000  
article-no.: 150 18200 0000

- alternating current AC
- wide voltage
- splinter protection
- Operating Time Counter
- potential free contacts

article-no.: 150 18300 0000  
article-no.: 150 18400 0000

- alternating current AC
- wide voltage
- splinter protection
- Operating Time Counter
- potential free contacts

## equipment PURION UV-Set 10 W short DUAL

PURION assembly system switch box  
article number: 290 12100 0000



PURION UV-lamp 10 W  
article number: 200 01300 0000



service-kit  
article number: 292 00900 0000



# UV-Set PURION 14 W DUAL



The UV set consists of two quartz-made protective tubes which are closed at one end while the other one is placed into a stainless steel flange, two PURION UV-lamps, the distribution box with its electronic cut-in unit and the connecting cables.

The flanges made from stainless steel have three boreholes by which they can be tightly screwed down (like for instance to the housing's walls).

applications	product line	PURION UV-Set 14 W DUAL
disinfection of air and climate channel	flow rate and disinfection power	depending on medium and geometrical structure
tank disinfection	radiation length	2x 220 mm
conveyor band disinfection	dimensions: seal flanges up to the end of the quartz tube	312 mm
surface disinfection	Ø quartz tube	23 mm
	Ø diameter flange	60 mm
	Ø hole circle flange seal	Ø 48, 3x 120°, Ø 5,5
	seal	VITON / FPM
advantages	weight	1,8 kg
	life time of lamps	10.000 h
	temperature max.	40°C
	number of lamps	2
not affecting odour or taste	protection grade	IP 65
low-maintenance operation	electrical connection	110-240 V 50/60 Hz
	total power	2x 14 W
low operational costs	over current protection	10 A

## alternating current (VAC)

article-no.: 150 07400 0000

- alternating current AC
- wide voltage
- splinter protection
- Operating Time Counter
- potential free contacts

article-no.: 150 18500 0000

- alternating current AC
- wide voltage
- splinter protection
- Operating Time Counter
- potential free contacts

article-no.: 150 08900 0000  
article-no.: 150 18600 0000

- alternating current AC
- wide voltage
- splinter protection
- Operating Time Counter
- potential free contacts

article-no.: 150 09100 0000  
article-no.: 150 18700 0000

- alternating current AC
- wide voltage
- splinter protection
- Operating Time Counter
- potential free contacts

## equipment PURION UV-Set 14 W DUAL

PURION UV-lamp 14 W  
article number: 200 01500 0000



service-kit  
article number: 292 00900 0000



PURION assembly system switch box  
article number: 290 12100 0000



# UV-Set PURION 17 W DUAL



The UV set consists of two quartz-made protective tubes which are closed at one end while the other one is placed into a stainless steel flange, two PURION UV-lamps, the distribution box with its electronic cut-in unit and the connecting cables.

The flanges made from stainless steel have three boreholes by which they can be tightly screwed down (like for instance to the housing's walls).

applications	product line	PURION UV-Set 17 W DUAL
disinfection of air and climate channel	flow rate and disinfection power	depending on medium and geometrical structure
tank disinfection	radiation length	2x 280 mm
conveyor band disinfection	dimensions:	
surface disinfection	seal flanges up to the end of the quartz tube	412 mm
	Ø quartz tube	23 mm
	Ø diameter flange	60 mm
	Ø hole circle flange	Ø 48, 3x 120°, Ø 5,5
	seal	VITON / FPM
advantages	weight	1,8 kg
	life time of lamps	10.000 h
no chemicals added to the medium being disinfected	temperature max.	40°C
not affecting odour or taste	number of lamps	2
low-maintenance operation	protection grade	IP 65
	electrical connection	110-240 V 50/60 Hz
low operational costs	total power	2x 17 W
	over current protection	10 A

## alternating current (VAC)

article-no.: 150 07600 0000

- alternating current AC
- wide voltage
- splinter protection
- Operating Time Counter
- potential free contacts

article-no.: 150 09500 0000

- alternating current AC
- wide voltage
- splinter protection
- Operating Time Counter
- potential free contacts

article-no.: 150 09300 0000  
article-no.: 150 18800 0000

- alternating current AC
- wide voltage
- splinter protection
- Operating Time Counter
- potential free contacts

article-no.: 150 09600 0000  
article-no.: 150 18900 0000

- alternating current AC
- wide voltage
- splinter protection
- Operating Time Counter
- potential free contacts

## equipment PURION UV-Set 17 W DUAL

PURION assembly system switch box  
article number: 290 12100 0000



PURION UV-lamp 17 W  
article number: 200 00300 0000



service-kit  
article number: 292 00900 0000



# AIRPURION mobile SINGLE



The AIRPURION mobile SINGLE consists of a PURION UV lamp which is placed in a quartz-made immersion tube system. The UV lamp is assembled on a robust and mobile rack. The AIRPURION mobile can be switched on and off via remote control. The AIRPURION mobile SINGLE is perfectly suitable for disinfection purposes in existing clean room environments.

<b>applications</b>		<b>product line</b>	
disinfection of air within the clean room industry		AIRPURION mobile SINGLE	
medical technology and laboratories		disinfection power	suitable for room volume up to 120 m <sup>3</sup>
ripening rooms		dimension (LxBxH) in mm	500 x 470 x 1550
		weight	21 kg
<b>details disinfection performance</b>		life time of lamps	10.000 h
		number of lamps	1
		electrical connection	110-240 V 50/60 Hz
		total power	1x 90 W
		over current protection	10 A
distance from PURION UV lamp			
guaranteed UVC-Dosis	2 m	5 m	
200 J/m <sup>2</sup>	15 minutes	70 minutes	
600 J/m <sup>2</sup>	50 minutes	200 minutes	
1000 J/m <sup>2</sup>	80 minutes	340 minutes	

### Horizontal position of the PURION UV lamp:

The area/air between the ceiling and the floor is disinfected. Moreover a surface disinfection of the floor and the ceiling is carried out. Two of the four lateral walls are not exposed to UV radiation.

### Vertical position of the PURION UV lamp:

The area/air between lateral walls is disinfected. Moreover a surface disinfection of the lateral walls is carried out. The floor and ceiling is exposed to the UV radiation.

article-no.: 164 00200 0000

- SINGLE
- DUAL
- splinter protection
- Operating Time Counter

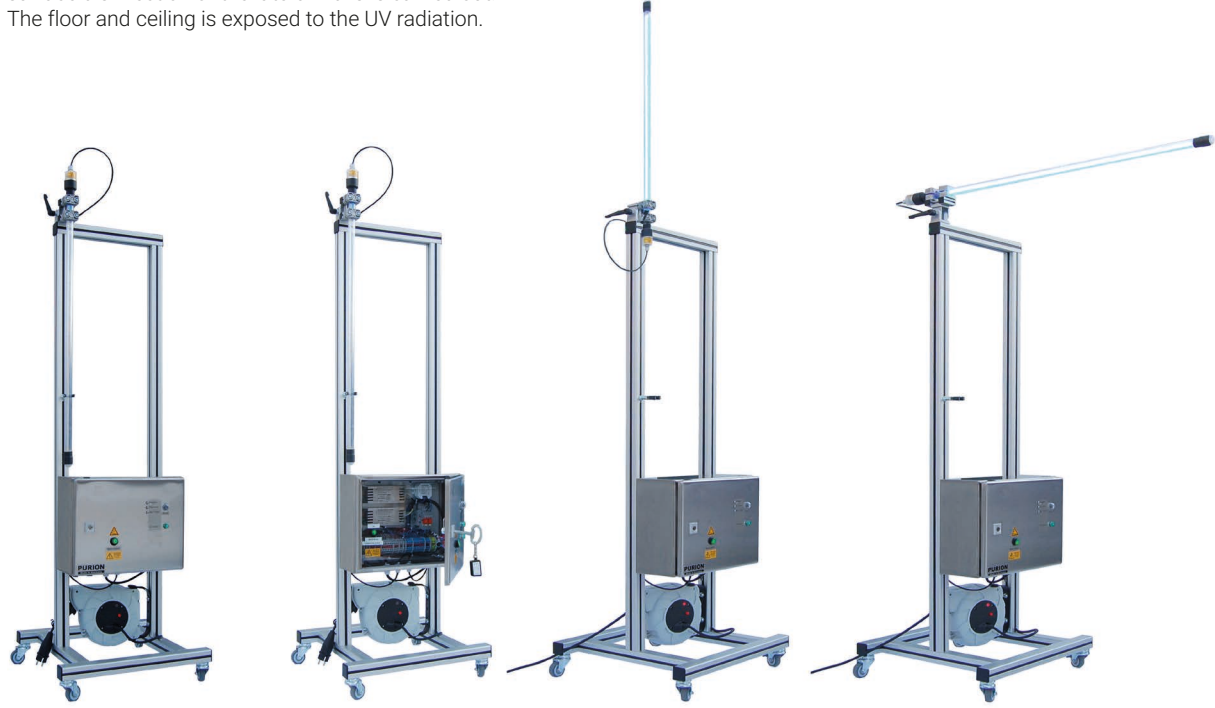

## equipment AIRPURION mobile SINGLE

PURION UV-lamp 90 W  
article number: 200 00600 0000



service-kit  
article number: 292 00900 0000



# AIRPURION mobile DUAL



The AIRPURION mobile DUAL consists of two PURION UV lamps which are placed in quartz-made immersion tube systems. The UV lamps are assembled on a robust and mobile rack. The AIRPURION mobile can be switched on and off via remote control. The AIRPURION mobile DUAL is perfectly suitable for disinfection purposes in existing clean room environments.

<b>applications</b>	<b>Product line</b>	<b>AIRPURION mobile SINGLE</b>
disinfection of air within the clean room industry	disinfection power	suitable for room volume up to 200 m <sup>3</sup>
medical technology and laboratories	dimension (LxBxH) in mm	500 x 470 x 1550
ripening rooms	weight	23 kg
<b>details disinfection performance</b>	life time of lamps	10.000 h
	number of lamps	2
	electrical connection	110-240 V 50/60 Hz
	total power	2x 90 W
	over current protection	10 A

guaranteed UVC-Dosis	distance from PURION UV lamp	
	2 m	5 m
200 J/m <sup>2</sup>	15 minutes	70 minutes
600 J/m <sup>2</sup>	50 minutes	200 minutes
1000 J/m <sup>2</sup>	80 minutes	340 minutes

Horizontal position of the PURION UV lamp:

The area/air between the ceiling and the floor is disinfected. Moreover a surface disinfection of the floor and the ceiling is carried out. Two of the four lateral walls are not exposed to UV radiation.

Vertical position of the PURION UV lamp:

The area/air between lateral walls is disinfected. Moreover a surface disinfection of the lateral walls is carried out. The floor and ceiling is exposed to the UV radiation.

article-no.: 164 00100 0000

SINGLE	DUAL	splinter protection	Operating Time Counter
	•	•	•



## equipment AIRPURION mobile DUAL

PURION UV-lamp 90 W  
article number: 200 00600 0000



service-kit  
article number: 292 00900 0000







# PURION UV-lamps









PURION low pressure UV Lamps are working without generating OZONE. They emit UV C radiation at a wave-length of 254 nm.



The guaranteed life time is valid in case of not exceeded 6 switching operations of the UV-lamp per day (in average). For temperatures above 40 C° special PURION UV-lamps that are operating with Amalgam technology are available.

advantages	product line	PURION UV-lamps
germs cannot become resistant to UV C radiation	total power	10 W – 106 W
PURION UV-lamps do not produce OZONE	lamp current	425 mA – 1,2 A
A special coating on the UV-lamps glass guarantees a stable UVC-radiation	lamp voltage	25 V – 88 V
low operational costs	life time of lamps	10.000 h / 8.000 h
special options for temperatures up to 90 C°	diameter	15 mm
PURION electronic ballasts are technically coordinated with the PURION UV-lamps	length (without pin)	212 mm – 843 mm
	length pin	7,7 mm
	temperatures	-20 C° up to 90 C°



## PURION UV-lamps - HIGH OUTPUT

 PURION UV-lamp 10 W article-no.: 200 01300 0000	• Temperature up to 40 C° Temperature up to 90 C° UVA-light Bio Vital	 PURION UV-lamp 14 W article-no.: 200 01500 0000	• Temperature up to 40 C° Temperature up to 90 C° UVA-light Bio Vital
 PURION UV-lamp 17 W article-no.: 200 00300 0000	• Temperature up to 40 C° Temperature up to 90 C° UVA-light Bio Vital	 PURION UV-lamp 36 W article-no.: 200 00400 0000	• Temperature up to 40 C° Temperature up to 90 C° UVA-light Bio Vital
 PURION UV-lamp 48 W article-no.: 200 00500 0000	• Temperature up to 40 C° Temperature up to 90 C° UVA-light Bio Vital	 PURION UV-lamp 90 W article-no.: 200 00600 0000	• Temperature up to 40 C° Temperature up to 90 C° UVA-light Bio Vital

## PURION UV-lamps - AMALGAM TECHNOLOGY

 PURION UV-lamp 42 W article-no.: 200 01700 0000	• Temperature up to 40 C° Temperature up to 90 C° UVA-light Bio Vital	 PURION UV-lamp 106 W article-no.: 200 00800 0000	• Temperature up to 40 C° Temperature up to 90 C° UVA-light Bio Vital
---	--	---	--

## SPECIAL OPTIONS

 UVA-lamp 6 W article-no.: 200 02000 0000	• Temperature up to 40 C° Temperature up to 90 C° UVA-light Bio Vital	 Bio Vital lamp 39 W article-no.: 200 01900 0000	• Temperature up to 40 C° Temperature up to 90 C° UVA-light Bio Vital
--	--	--	--

## Hints regarding PURION UV-lamps

**PURION low pressure UV Lamps are working without generating OZONE. They emit UV C radiation at a wavelength of 254 nm. At this wavelength UV radiation is most effective against bacterias, viruses and spores.**

A special coating on the inside of the lamp tube guarantees stable UV C radiation. The lamp's glass serves as a filter for UV radiation < 240 nm.

At the end of the guaranteed life time PURION UV Lamps emit at least 60% of the initial UV C radiation intensity.

## advantages

- germs and bacterias cannot become resistant to UV C radiation,
- PURION UV Lamps do not generate OZONE,
- disinfection by means of PURION UV Lamps implies low costs compared to chemical methods.

For the optimal operation of PURION UV lamps the correct handling and maintenance is essential. The following rules should be considered:

- It is unfavorable for the life span if the PURION UV lamp is switched very often. Every switch on reduces the life time approx. 1/2 h - 1 h.  
Therefore: please only switch of the PURION UV-lamps if the expected interruption of operation is at least 30 minutes.
- The PURION UV-lamps should not be touched with fingers at the quartz made tube.  
Sweat of the hand is very aggressive against quartz and causes re-crystallization (cloudiness).  
If a PURION UV-lamp has been touched it is necessary to clean it with the PURION Service Kit.

Considering of this points ensures that the UV lamp reaches it's maximum life time.

**The guaranteed life time of operation is valid in case of not exceeding 6 switching operations of the UV lamp per day (in average). To keep the warranty valid the PURION UV Lamps needs to be operated with PURION electronic ballasts.**

## Caution

During operation of PURION UV-lamps regulation and official guidelines have to be considered!

UV radiation is dangerous for human skin and eyes! Eyes and skin have to be appropriately protected. The user will be responsible for his own safety, as well as for the safety of people who are staying in areas where these radiation is used!

Please bear in mind that materials which are not UVC resistant may be damaged!

# PURION immersion tube systems for reactors

The PURION immersion tube systems for reactors consists of a head made from stainless steel and a special quartz glass that allows for transmittance of UVC light. Optionally configurations as PRO systems or with Splinter Protection are available.

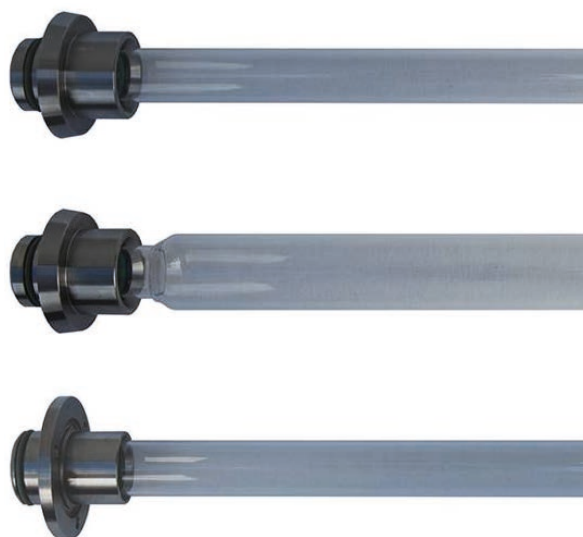

## PURION Immersion tube systems for reactors made from stainless steel



Immersion tube system length 229 mm  
article-no.: 104 00201 0000

reactor	standard	PRO
•		



Immersion tube system length 312 mm  
article-no.: 105 00201 0000  
article-no.: 105 00203 0000

reactor	standard	PRO
•	•	
•		•



Immersion tube system length 412 mm  
article-no.: 110 00201 0000  
article-no.: 110 00203 0000

reactor	standard	PRO
•	•	
•		•



Immersion tube system length 570 mm  
article-no.: 120 00201 0000

reactor	standard	PRO
•		



Immersion tube system length 920 mm  
article-no.: 130 00201 0000  
article-no.: 130 00202 0000

reactor	standard	PRO
•	•	
•		•

## PURION Immersion tube systems for reactors made from PVC-U



Immersion tube system length 412 mm  
article-no.: 110 00202 0000

reactor	standard	PRO
•		



Immersion tube system length 570 mm  
article-no.: 120 00202 0000

reactor	standard	PRO
•		



Immersion tube system length 920 mm  
article-no.: 130 00204 0000

reactor	standard	PRO
•		

# PURION immersion tube systems for UV-Sets

The PURION immersion tube systems for UV-Sets consists of a head made from stainless steel and a special quartz glass that allows for transmittance of UVC light. Optionally configurations with Safety Basket or with Splinter Protection are available.

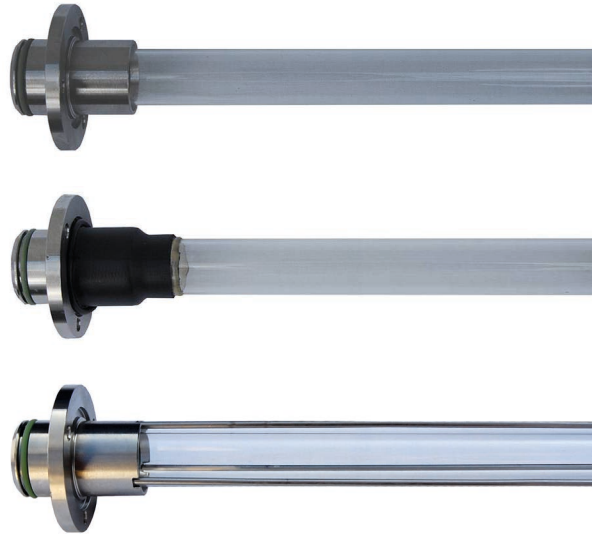

## PURION Immersion tube systems for UV-Sets without Splinter Protection



Immersion tube system length 229 mm  
article-no.: 104 00203 0000

UV-Set	Splinter Protection	Safety Basket
•		



Immersion tube system length 312 mm  
article-no.: 105 00202 0000

UV-Set	Splinter Protection	Safety Basket
•		



Immersion tube system length 412 mm  
article-no.: 110 00202 0000

UV-Set	Splinter Protection	Safety Basket
•		



Immersion tube system length 570 mm  
article-no.: 120 00202 0000

UV-Set	Splinter Protection	Safety Basket
•		



Immersion tube system length 920 mm  
article-no.: 130 00204 0000

UV-Set	Splinter Protection	Safety Basket
•		

## PURION Immersion tube systems for UV-Sets with Splinter Protection



Immersion tube systems length 229 mm  
article-no.: 104 00204 0000

UV-Set	Splinter Protection	Safety Basket
•	•	



Immersion tube system length 312 mm  
article-no.: 105 00204 0000

UV-Set	Splinter Protection	Safety Basket
•	•	



Immersion tube system length 412 mm  
article-no.: 110 00205 0000

UV-Set	Splinter Protection	Safety Basket
•	•	



Immersion tube system length 570 mm  
article-no.: 120 00204 0000

UV-Set	Splinter Protection	Safety Basket
•	•	



Immersion tube system length 920 mm  
article-no.: 130 00206 0000

UV-Set	Splinter Protection	Safety Basket
•	•	

## PURION Immersion tube systems for UV-Sets with Safety Basket



Immersion tube system length 920 mm  
article-no.: 130 00209 0000

UV-Set	Splinter Protection	Safety Basket
•		•



# PURION UV lamp cables

PURION UV lamp cable 1,50 m  
article-no.: 250 01500 0000



PURION UV lamp cable 3 m  
article-no.: 250 02800 0000



PURION UV lamp cable 5 m  
article-no.: 250 04300 0000



PURION UV lamp cable 10 m  
article-no.: 250 09600 0000



# PURION assembly systems



PURION assembly systems allow for a convenient installation of the PURION UV-lamps. Several configurations are available for different applications.

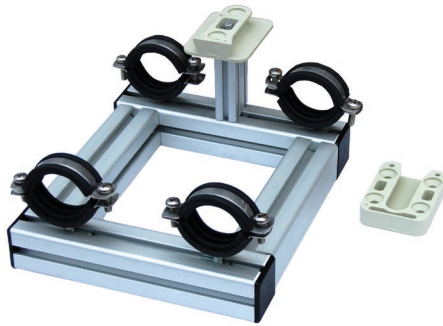

## PURION assembly system



PURION assembly system  
Single 1  
article-no.: 290 11000 0000  
article-no.: 290 10900 0000

- |   |                                |
|---|--------------------------------|
| • | stainless steel                |
| • | galvanized                     |
| • | assembly system for switch box |
| • | assembly system for Reactor    |



PURION assembly system  
Single 2  
article-no.: 290 11200 0000  
article-no.: 290 11100 0000

- |   |                                |
|---|--------------------------------|
| • | stainless steel                |
| • | galvanized                     |
| • | assembly system for switch box |
| • | assembly system for Reactor    |

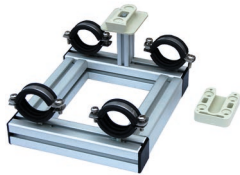

PURION assembly system  
Dual 1  
article-no.: 290 11400 0000  
article-no.: 290 11300 0000

- |   |                                |
|---|--------------------------------|
| • | stainless steel                |
| • | galvanized                     |
| • | assembly system for switch box |
| • | assembly system for Reactor    |

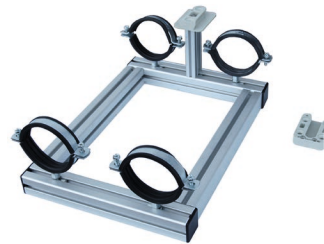

PURION assembly system  
Dual 2  
article-no.: 290 11600 0000  
article-no.: 290 11500 0000

- |   |                                |
|---|--------------------------------|
| • | stainless steel                |
| • | galvanized                     |
| • | assembly system for switch box |
| • | assembly system for Reactor    |



PURION assembly system switch box  
article-no.: 290 12100 0000

- |   |                                |
|---|--------------------------------|
| • | assembly system for switch box |
| • | assembly system for Reactor    |

## AIRPURION assembly system



AIRPURION wire suspension  
article-no.: 160 00011 0000

- |   |   |
|---|---|
| • | ceiling suspension with variable height |
| • | direct ceiling suspension               |



AIRPURION mounting rack  
article-no.: 160 00040 0000

- |   |   |
|---|---|
| • | ceiling suspension with variable height |
| • | direct ceiling suspension               |

# filters

for treatment of water



Combination of filters to supplement the PURION UV plants enable the complete recycling of the water combined with a compact construction design and efficient energy consumption. The replacement of the filter cartridges is to be reviewed at least on annual basis. On request the different filters will be provided pre assembled.

advantages	product line	filter as additional equipment for PURION UV-plants
compact design	height	335 mm
robust construction	diameter	135 mm
low energy consumption	configuration	pre filter 60 µm fine filter 20 µm activated carbon filter de-ironing filter softener
easy replacement of cartridges	connection	1" inside thread
low investment costs	working pressure	8 bar max.
low operational costs	temperature	0 - 50 C°



filter housing 10" x 2,5"  
article-no.: 410 01400 0001

filter housing  
cartridge

**The PURION UV plant needs to be installed behind the last filter the water flows through. Herewith disinfection of the water close to the sampling point is ensured.**



cartridge 60 µm  
article-no.: 410 00800 0000

filter housing  
cartridge



cartridge 20 µm  
article-no.: 410 00900 0000

filter housing  
cartridge



cartridge activated carbon  
article-no.: 410 01000 0000

filter housing  
cartridge



cartridge de-ironing  
article-no.: 410 04000 0000

filter housing  
cartridge



cartridge softener  
article-no.: 410 03900 0000

filter housing  
cartridge



# filter

for treatment of water



Combination of filters to supplement the PURION UV plants enable the complete recycling of the water combined with a compact construction design and efficient energy consumption. The replacement of the filter cartridges is to be reviewed at least on annual basis. On request the different filters will be provided pre assembled.

advantages	product line filter as additional equipment for PURION UV-plants	
compact design	height	335 mm
robust construction	diameter	180 mm
low energy consumption	configuration	pre filter 60 µm fine filter 20 µm activated carbon filter
easy replacement of cartridges	connection	1" inside thread
low investment costs	working pressure	8 bar max.
low operational costs	temperature	0 - 50 C°



Filter housing 10" x 4,5"  
article-no.: 410 05000 0000

filter housing  
Cartridge  
•

**The PURION UV plant needs to be installed behind the last filter the water flows through. Herewith disinfection of the water close to the sampling point is ensured.**



cartridge 60 µm  
article-no.: 410 05100 0000

filter housing  
cartridge  
•



cartridge 20 µm  
article-no.: 410 05200 0000

filter housing  
cartridge  
•



cartridge activated carbon  
article-no.: 410 05300 0000

filter housing  
cartridge  
•

# maintenance support / others

PURION UV-safety goggles  
article-no.: 292 00700 0000



UVC-light is dangerous for the human eye. The PURION safety goggles effectively protect the eyes against the UVC radiation. The visible part of the light is not retained.

Especially during operation of the PURION UV Sets or the AIR-PURION product line it is important to protect the eyes.

PURION Service KIT  
article-no.: 292 00900 0000



The PURION Service KIT enables a reliable and convenient cleaning of the immersion tube system. Cleaning should be carried out latest when the UV lamp is replaced at the end of the lifetime or if operation conditions require it.

The special cleaning tissues made from 100% cotton guarantee that the sensitive quartz glass is not damaged by scratches during the cleaning procedure.

The cleaning solution ensures that after the cleaning no residues of soap can lead to foam formation. Therefore the PURION Service KIT is suitable to drinking water applications.

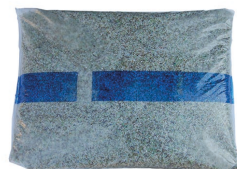

PURION Quartz-granulate  
article-no.: 292 02300 0000  
article-no.: 292 02400 0000

• fine grain  
• rough grain

The PURION filter granulates made from special quartz is applied within the PURION Pool plants.

The Quartz-granulate is available with rough grain and fine grain. Therefore sediments are removed very efficiently from the circulation water before the UV based disinfection is carried out.

The Quartz-granulate can be flushed out from filtrated sediments very easy during backwash procedure.

# Company

with TRADITION & INNOVATION



The PURION® GmbH is a European company with a global focus. Our future-oriented and ecologically friendly methods help to improve a worth living environment.

PURION® GmbH is member of the BMBF-program „Twenty20 - Partnership for Innovation“, „Research Regarding UV-LED-Light for Innovative Applications within Health Care, Water Treatment, Production Technology and Sensor Technology“. Highly reputable German research institutions are co-operation partners within this program.

PURION® GmbH is partner of the cooperation's network HySic – Hygienic Safety. The aim is to develop and to realize solutions for the improvement of the hygienic safety in different important applications.



To ensure compliance with high quality standards production and management processes of PURION GmbH are established in line with the certified standard management system DIN EN ISO 9001:2015. The certification is renewed annually.



## PURION GmbH

Schubertstraße 18  
98544 Zella-Mehlis  
Germany

T: +49 (0)3682 / 479087  
F: +49 (0)3682 / 479086  
E: [uv-technology@purion.de](mailto:uv-technology@purion.de)  
H: [www.purion.eu](http://www.purion.eu)



## I. General terms of the contract

The Customer has notice of the following general conditions for sales and supplies. The Customer agrees with the fact that following general conditions are essential elements of contracts concluded between the Customer and the Supplier.

## II. Scope of supplies and services

1. The scope of any supplies or services effected hereunder shall be governed by the written statements supplied by the two parties. If a contract is concluded and the parties have failed to make any such statements, then either the Supplier's or the Service Provider's (hereinafter referred to as »Supplier«) written order confirmation, or, failing such, the written order from the Customer shall be binding.
2. For all supplies or services, the provisions stipulated by the Verband Deutscher Elektrotechniker (= Association of German Electro-technical Engineers) shall be applied as far as they are relevant for the safety of the supplies and services. Variations are allowed if the same safety standard is ensured by other means.
3. The Supplier reserves the unrestricted right of ownership and the copyrights to all quotations, drawings, and other documentation; they shall be made available to third parties only if prior written approval from the Supplier has been obtained.
4. The scope of the delivery shall be as indicated in the written order confirmation from the Supplier. If such confirmation is not available, the delivery note shall be considered the order confirmation.
5. Any verbal collateral agreement shall be effective only if confirmed in writing.

## III. Price

The prices are understood net, plus V.A.T. as provided by law. They are valid ex works, exclusive of packaging, freight charges, postage, insurance, and other additional expenses. Samples or similar preparatory work occasioned by the Customer will be charged for even if the contract is not awarded.

## IV. Reservation of title

The goods remain the property of the Supplier until all claims he may have vis-a-vis the Customer as a result of the said business transaction are satisfied. Prior to this, any pledging or transfer of ownership by way of security is not allowed, and reselling is only permitted for resellers in the normal course of business under the proviso that the reseller receives payment from his customer. Any costs incurred in connection with interventions shall be borne by the Customer.

## V. Terms of payment

1. The payments shall be effected free place of payment of the Supplier.
2. The Customer may effect set-offs only against undisputed or legally established debts.
3. In case of non-observance of payment terms, or if reasonable doubts in respect of the credit-worthiness of the Customer exist, the Supplier has the right to request advance payments and other payments for all outstanding accounts and even for those accounts that are not yet due, have any unpaid deliveries returned at the Customer's expenses, or withdraw from the contract without notice.

## VI. Time allowed for deliveries and services

1. Delivery times/deadlines shall only be binding if expressly approved by the Supplier in writing. Compliance with the deadlines can only be assured if the Customer has fulfilled all of its contractual obligations and/or has effected any agreed advance payments and/or has met any other duty he may have in respect of prior performance or cooperation. Another prerequisite for observance of the deadlines is the correct and on-time delivery by the suppliers of the Supplier as far as the Supplier has selected them with due care and in a business-like manner.
2. The deadline is considered met if the ready-for-use consignment was dispatched or collected within the time specified for delivery or performance. In case of delayed delivery due to Customer's fault, the deadline is considered met if the information of readiness for dispatch was given within the agreed period of time.
3. If proof can be furnished that non-observance of the deadline for the deliveries and services happened because of mobilization, war, riot, strike, acts of the authorities, or occurrence of unpredictable circumstances, the time shall be reasonably extended.
4. The same holds if Sub-Contractors are affected by these circumstances.
5. If the Supplier is in default, and if an additional period of time granted by the Customer has lapsed without any response on the part of the Supplier, the Customer has the right to withdraw from contract. Damages for non-performance cannot be claimed unless the default occurred as a result of the Suppliers' wrongful intent or gross negligence.
6. In case dispatch or delivery of the goods are delayed on request of the Customer, then, beginning one month after the date of advice of readiness for shipment, a storage fee amounting to ½ % of the invoice amount can be charged to the Customer for any commenced month; such storage fee, however, shall be limited to 5% unless proof of higher costs is furnished.
7. In case of orders for goods to be delivered on demand, the call time for the overall order shall be one year from the date of confirmation by the Supplier. The Customer agrees to inform about his forthcoming request not later than four production weeks in advance. If the Customer fails to demand the full quantity until expiration of the time specified, the Supplier may, after prior notice, opt for performance or withdraw from the contract. Claims for damages, if any, shall not be affected.

## VII. Passing of the risk

1. Upon delivery of the goods to the carrier company, the risk will pass to the Customer, even if delivery on carriage paid basis or self-collection had been agreed upon, or the ready-for-use consignment was dispatched or collected.
2. In the absence of other agreements, the Supplier is free to choose the kind of packaging, the routing, and the mode of dispatch. The costs for packaging shall be borne by the Customer.
3. The packaging will be effected with best care, the dispatch will be effected to the Supplier's best discretion. At the Customer's request and expenses, the Supplier will insure the consignment against damage by breakage, transport damage, and fire damage.
4. In case the dispatch or delivery of the goods is delayed on request of the Customer or for reasons lying with him, then the risk shall pass on to him for the time of the delay. The Supplier, however, undertakes to effect the insurances required by the Customer at the Customer's request and expenses.

### VIII. Acceptance

1. Delivered items have to be accepted by the Customer, even if those items show minor shortcomings.
2. Partial deliveries are allowed.

### IX. Liability for defects

For any defects, including the absence of warranted qualities, the Supplier shall be liable as follows:

1. All parts or services which - within a period of 24 months from the date of the passing of the risk, irrespective of their operating time - become unuseable as a consequence of any circumstances that have existed already prior to the time of the passing of the risk, i.e. in particular, due to defective design, faulty material, or faulty workmanship, or whose useability is considerably impaired, shall, at the Supplier's option and at no cost, either be repaired or replaced by new items or be provided again.  
Any such defects found shall be promptly notified to the Supplier in writing; the goods shall be sent to the Supplier for examination.
2. The Customer affords the Supplier the opportunity and grants it such reasonable period of time as necessary to remedy the defects. If he fails to do so, the Supplier shall be exempt from the liability for defects.
3. In case the Supplier fails to remedy the defect within the additional period of time granted to him, the Customer may require the contract to be cancelled (exchange) or request reduction of the price (diminution).
4. The Customer agrees to fulfill all his contractual obligations, i.e. in particular regarding the agreed Terms of Payment. In case a notification of defects is put forward, then payments from the Customer may be withheld to an amount reasonably proportionate to the defects found
5. The liability for defects does not include normal wear as well as any defects developing after the passing of the risk as a result of faulty or negligent handling, due to non-observance of specifications issued by the Supplier, excessive use, unsuitable production equipment, and such influences of a chemical, electrochemical or electrical nature which are not expressly provided for in the contract; not included are also defects attributable to the use of material supplied by the Customer.
6. Any changes or repairs performed in an improper manner by the Customer or third parties without the prior consent from the Supplier will void any liability for the consequences resulting from this.
7. The warranty period shall be 3 months for remedied items, and six months for replacement deliveries. It runs, at least, until the end of the original warranty period for the delivered item. The duration of the warranty period for defects shall be extended by the duration of the downtime necessary for such remedying, replacement deliveries or services.
8. The provisions regarding warranty periods under 1. and 7. shall not apply as far as longer periods are provided for by law.
9. Any further claims of the Customer vis-a-vis the Supplier and the Supplier's agents shall be excluded, in particular claims because of damages not to the delivery item proper. This shall not apply as far as either liability to the Product Liability Act, e.g. for personal injuries and damages to objects of private use, or compulsory liability in cases of wrongful intent, gross negligence, or absence of warranted qualities, is invoked.
10. The Articles 1. through 9. shall also apply to any right to claim corrective work, replacement delivery or damages the Customer may have as a result of advice or consultation provided under the contract, or due to breach of additional contractual obligations.

### X. Impossibility of performance, adjustment of contract

If it should be impossible for the Supplier or the Customer to effect the agreed supplies or services, then the general legal principles shall apply as follows:

The Customer is authorized to claim damages from the Supplier in case of premeditation or gross negligence. Such damages, however, shall be limited to 10% of the value of that part of the delivery or service which cannot be put into operation as desired due to the said impossibility. Any claims for damages on the part of the Customer exceeding the said limit of 10% are excluded. This shall not apply if compulsory liability is invoked, e.g. in instances of wrongful intent or gross negligence. Nothing hereunder shall affect the Customer's right to withdraw from the contract.

Inasmuch as unforeseen circumstances to Article V, clause 3, para. 1, effect a considerable change in the economic significance or the contents of the delivery or service, or exert a major influence on the Supplier's operations, the contract shall be reasonably adapted in accordance with the requirements of good faith. As far as this proves to be in conflict with economic interests, the Supplier has the right to withdraw from the contract. If he opts to exercise this right, he shall, after he became aware of the consequences resulting from said circumstances, inform the Customer accordingly even if extension of delivery time had been agreed upon with the Customer.

### XI. Other claims for damages

Claims for damages on the part of the Customer resulting from breach of contract, breach of obligations during the contract negotiations, or tort, are excluded. This shall not apply inasmuch as either liability according to the Product Liability Act, e.g. for personal injuries and damage to goods of private use, or compulsory liability for cases of wrongful intent and gross negligence, is invoked. The same limitation of liability shall also be valid for the Customer.

### XII. Place of jurisdiction

1. If the Customer is a fully qualified merchant, the Supplier is free to decide if either the place of the Supplier's head office or the place of the Supplier's branch office shall be the exclusive place of jurisdiction for all direct or indirect disputes arising from the contractual relationship.
2. The contractual relationship shall be governed exclusively by German law, without any recourse to the UN Right of Purchase (CISG).

### XIII. Validity of the contract

If any provision of the contract is held to be ineffective, this shall not affect and impair the validity of the other provisions. The foregoing shall not apply if adherence to the contract would constitute an unreasonable hardship for one of the parties.

# **WARRANTY**

## for PURION UV-lamps

The PURION® GmbH grants for low pressure UV lamps the following warranty:

- Basis of the decision on a warranty or replacement is the evaluation in our PURION labs. Therefore complaints need to be sent to PURION® GmbH.
- The warranty is granted for 10.000 hours of operation for PURION UV low pressure lamps and 8.000 hours for PURION UV Amalgam lamps up to maximum 2 years from the date of delivery.
- Up to 1.000 hours of operation the lamps will be fully replaced.
- Up to 10.000 hours of operation the replacement and financial compensation will be proportional referring to the operating time.
- For PURION Amalgam lamps the proportional compensation refers to the operation time of 8.000 hours.
- To keep the warranty valid the number of switching operation must not exceed an average of 5-6 per day.
- Operating time and switching operations needs to be proved with suitable measures.
- To keep the warranty valid the PURION UV lamps needs to be operated with PURION electronic ballasts.
- Breakage of glass will not be compensated.

These conditions are valid, when no other special agreement is stated. Special agreements must put down in writing.